



**YMGi Group**, POB 1559  
**YMGi Group New Energy**, POB 1668  
 O'Fallon, MO 63366, USA  
 Tel: (866)833-3138 Fax: (866)377-3355  
 Web Site: [www.ymgigroup.com](http://www.ymgigroup.com)  
 Email: [info@ymgigroup.com](mailto:info@ymgigroup.com)

Literature Part No: Lit-WMMS-User Manual-0102-20130201  
 For WMMS Series of Product 09 to 60K Btu/h Single/Dual/Tri/Quad Zone (Cooling, Heat Pump W or W/O Ele. Heater)  
 Subject to Continuous Engineering Improvement without Prior Notice.

YMGi is the Trademark and Property of YMGi Group. Copyright of YMGi Group.



*YMGi, Engineered Comfort Products for A Sustainable and Efficient Green World !*

## USER'S MANUAL

### AIR CONDITIONER AND HEAT PUMP WALL MOUNT MINI SPLIT TYPE Series M2 SINGLE, DUAL, TRIPLE, QUAD ZONES

(This Manual is Good for Mini Split Wall Mount Product Line of Different Brands Made by  
 YMGi Group-YMGi, YMGi Products, and Others Claimed by YMGi Group,  
 POB 1559, O'Fallon, MO, USA-Check with [info@ymgigroup.com](mailto:info@ymgigroup.com) or [sales@ymgigroup.com](mailto:sales@ymgigroup.com))



#### **⚠ WARNING**

This product is designed and manufactured free from defects in material and workmanship under the normal use and maintenance. Installation, operation, maintenance and service shall follow professional practices for regular cooling and heating equipment, NEC, State, City or Local Codes and related manuals from us. Otherwise, damage to equipment or property even injury to people may occur.

**Installer:** Currently licensed HVAC installer only, Read this manual before installation. Sign on the warranty registration card.

**User:** Keep this manual for future maintenance and service use.

**Service:** Use this manual for service reference.



LITERATURE Part No: LIT-WMMS-USER MANUAL-0102-20130201

## IMPERATIVE

### ⚠ CAUTION

- All Units Shall Be Installed by Experienced or Licensed HVAC Contractor or Technician. Customers must NOT Install This Unit by Themselves or Hire Non-Licensed Persons to Do the Job. We Decline Any Consequences, Including Damage to Unit, People, Properties and Others Resulted from Such Behaviour.
- Following NEC, State and Local Codes and Installation Instructions of All Units, Otherwise Unit Warranty Will Be Void and Serious Damage To People Or Property May Be Caused.
- Read Manuals Thoroughly before Installation.
- Always Keep Your External Unit In A Vertical Position During Handling.

### ⚠ WARNING

- YMGI Group Shall NOT Take Any Responsibilities for Any Damage or Loss Due to Improper Installation or Operation or Natural Disaster.
- Don't Supply Power until All Wiring and Tubing and Checking is Completed.
- Ground the Unit Following Instructions and NEC, State and Local Codes.

### ⚠ DANGER

- Connect All Wiring Securely. Loose Wire or Other Bad Contact May Cause Arc or Overheating and Fire Hazard.

## LIABILITIES

Manufacturer shall not be responsible for problems due to Do-it-Yourself(DIY) installation or other bad installation or abnormal usage of this unit such as unreasonable capacity or efficiency expectation of the unit, working out of the designed or recommended outdoor weather conditions, and

- A bad connection of the connecting pipes.
- Folding or deterioration of connecting pipes during installation.
- Shocks during the installation due to unprofessional or incautious installation or usage.
- An installation or usage not conforming to the regulations or factory recommendations.
- Possible costs, services or disasters caused by such bad installation or abnormal usage.
- A not very effective operation of the air-conditioner due to a bad vacuum.
- A distance between indoor and outdoor units that exceeds the recommended ranges.
- The presence of foreign substances left in the air-conditioner during installation.
- The under performance due to such bad installation or abnormal usage.
- Water leakage problems due to such bad installation of drain hoses.
- Refrigerant or oil leakage due to unsuccessful pipe connections.
- Problems caused by rough handling unit during bad installation or abnormal usage.

### End User Technician Contact of Technical Support-Manufacturer

Toll Free Number: 1-866-833-3138 x 703

Email: [techsp@ymgigroup.com](mailto:techsp@ymgigroup.com)

(End user needs to contact installation or service technician to check the unit, before the technicians contact manufacturer technical support-straight technical communication)

## CONTENTS

LIMITED PRODUCT WARRANTY POLICIES .....	2
LIMITED PRODUCT WARRANTY REGISTRATION CARD .....	3
CUSTOMER AND TECHNICIAN MUST READ .....	4
IMPORTANT NOTES .....	12
SAFETY-ATTENTIONS .....	13
BRIEF INTRODUCTION TO MINI SPLIT WALL MOUNT SYSTEM .....	14
MINI WALL MOUNT SYSTEMS-MODELS .....	15
SYSTEM COMPONENTS-GENERAL .....	16
SYSTEM COMPONENTS & INSTALLATION CLEARANCE: SINGLE ZONE .....	17
SYSTEM COMPONENTS & INSTALLATION CLEARANCE: DUAL ZONE .....	18
SYSTEM COMPONENTS & INSTALLATION CLEARANCE: TRIPLE ZONE .....	19
SYSTEM COMPONENTS & INSTALLATION CLEARANCE: QUAD ZONE .....	20
INDOOR UNIT-MAJOR COMPONENTS .....	21
REMOTE OR LINE CONTROL .....	21
LED DISPLAY PANEL .....	22
REPARATION OF REMOTE OR LINE CONTROL .....	22
FUNCTIONS-REMOTE OR LINE CONTROL .....	23
OPERATION OF THE UNIT .....	25
SERVICE AND MAINTENANCE .....	27
DOUBTING ABOUT UNIT FAILURE .....	29
DIAGNOSIS CODE & TROUBLE-SHOOTING GUIDELINE .....	31
WARRANTY AND TECH. SUPPORT .....	32
USER NOTES AND SERVICE LOG .....	33
MEMO .....	34



## LIMITED PRODUCT WARRANTY POLICIES

The YMGI products are designed and manufactured free from defects in workmanship, and materials for normal use. However, for any reason, including many handlings and occasions between the YMGI factories/warehouses and where you receive the products, the unit doesn't work, YMGI Group will help to remedy the occurrence in the following warranting ways:

**Compressor:** YMGI will warrant the compressor of YMGI-validated and approved warranty filing, for a period of 5 years from the date of successful installation at original location.

**Parts:** YMGI will warrant parts of YMGI-validated and approved warranty filing, for one year from the date of successful installation at original location.

All warranty compressors and parts replaced will become the sole property of YMGI Group and must be returned to YMGI Group upon request. Warranty parts may be new or refurbished. All parts are tested and approved before shipping.

**At no time does the YMGI Group warrant labor cost of any type. Warranty will start from the date of successful installation at initial location, or 90 days as of original shipping date from YMGI Group, whichever comes first.**

**This is a standard warranty of limited liability and DOES NOT cover the following:**

- \* Any damage or repairs to properties, or persons as an incident or consequence of improper or faulty transportation, installation, operation, maintenance or service.
- \* Damage caused by frozen or broken water hoses or refrigeration pipes in the event of equipment failure.
- \* Any damage as a result of floods, fire, wind, lightning, accidents, corrosive atmosphere or any other conditions beyond the control of YMGI Group.
- \* Any damage due to interruption or inadequate electrical service to equipment.
- \* Any products that are installed outside the US or Canada.
- \* Any unit that has been moved from the original installation address.
- \* Any labor costs associated with the installation or service of the unit.
- \* Poor unit performance due to improper unit selection (SEER, Unit size).

**To validate the above warranties, ALL the following conditions must all be fulfilled:**

1. The unit was fully (100%) and successfully installed by licensed or certified HVAC technicians.
2. The unit was installed following all NEC, state and local codes.
3. The unit was installed following all instructions and manuals made by YMGI Group.
4. ALL fields, especially the technician-checklist, of the **Limited Warranty Registration Card/Form** were filled completely by the installing technician and signed by both the installing company technician and the unit owner.
5. The **Limited Warranty Registration Card/Form** and a copy of the original installing company's invoice had been received by YMGI Group-Warranty Dept., POB 1559, O'Fallon, MO 63366, within 7 days of successful installation.

**No warranty filing will be validated or approved, if any one of the above 5 conditions is not met.**

**Product registration doesn't guarantee the validity of this limited warranty statement.**

**Steps to follow for warranty part replacement:**

1. Installing or service technician contacts YMGI tech support at 1-866-833-3138 ext 703 from the jobsite, to double-check and confirm with YMGI Technical support the exact part(s) needed to fix all the problems.
2. YMGI will check the customer's warranty filing. Parts for validated and approved warranty will not be charged. Parts of invalid warranty filing or unapproved warranty requesting, will be charged accordingly.
3. YMGI will ground ship out the parts ASAP. Expedited shipping is available at the customer's cost.
4. Replacement parts of approved warranty registration are to be warranted for the remainder of the 1 year parts and 5 year compressor warranty. Purchasing of replacement parts of invalid warranty filing or unapproved warranty requesting, will be as they are and bear no warranty.

YMGI keeps on improving products with various engineering changes without prior notice. Such improvements or changes include but not limited to product specification, appearance, functions, sizes, packaging and others. These improvements or changes will not void the limited warranty stated herein. YMGI keeps the final explanation of this warranty policy.

## LIMITED PRODUCT WARRANTY REGISTRATION CARD



**YMGI GROUP**  
Innovative, Competitive, Efficient & Convenient

## LIMITED PRODUCT WARRANTY REGISTRATION CARD / FORM

YMGI to Fill Top Portion, at Shipping, and Keep Copy A; Center Copy B for Installer to Fill and Mail back to YMGI; Bottom Copy C for Customer to Fill and Keep

For YMGI Use Only	The Company the Unit Was Sold Through: _____	Shipping Packing List Number: _____	Registration Card Serial No. _____		
	Did the Company Pay to YMGI: _____	HVAC Contractor/Technician--Name _____	Date the Filled Registration Card YMGI Received: _____		
	Installation Invoice Attached to the Registration Card _____	Hired YMGI-Recommended HVAC Contractor/Technician? _____	Unit(s) Work Successfully (Yes/No): _____	Warranty Approved _____	Warranty Denied _____
Outdoor Serial Number (One Outdoor Unit, One Registration Card/Form): _____		Indoor Serial Number: _____	For Multi Zone Units _____	Unit #1 _____	Unit #5 _____
				Unit #2 _____	Unit #6 _____
				Unit #3 _____	Unit #7 _____
				Unit #4 _____	Unit #8 _____

**Contact Where the Units are Installed:**  
Name: \_\_\_\_\_ Phone: \_\_\_\_\_ Fax: \_\_\_\_\_  
Address: \_\_\_\_\_ Email: \_\_\_\_\_  
City: \_\_\_\_\_ State (Province): \_\_\_\_\_ Country: \_\_\_\_\_

<b>Contact of the Installing HVAC Contractor/Technician:</b> Technician Full Name (Print): _____ HVAC Technician's Company Name: _____ Address: _____ Currently Licensed or Certified HVAC Technician License or Certification Number: _____ Official Phone # to Check the License Validity: _____	<b>YMGI-Recommended Contractor/Technician:</b> Phone/Fax: _____ Email: _____ City:State (Province): _____ License Approved or Certified by: _____
---	---

**List for Installing HVAC Technician to Double Check Installation Quality, and Warranty Processing Purpose (if not filled by technician, or not filled fully, warranty will void)**

- 1) Are you the only one to install whole system? If not, % of installation done by you (HVAC technician).
- 2) What had been done, prior to your arrival?
- 3) Did you read the User Manual and Installation Instruction, before you started the installation?
- 4) Who unpacked the unit and accessory boxes to check for damage?
- 5) Supply electrical power V/Ph/Hz measured at wiring terminal block of Indoor unit: \_\_\_\_\_ outdoor unit: \_\_\_\_\_
- 6) Incoming electrical power V/Ph/Hz measured at terminal blocks of indoor unit: \_\_\_\_\_ outdoor unit: \_\_\_\_\_
- 7) Wire gauge, length and terminal colors between circuit breaker/disconnect switch to outdoor unit: \_\_\_\_\_
- 8) Wire gauge, length and terminal colors between each indoor and outdoor unit: Unit A \_\_\_\_\_ Unit B \_\_\_\_\_ Unit C \_\_\_\_\_ Unit D...
- 9) The size of HVAC circuit breaker/fuse or disconnect switch to the outdoor unit: \_\_\_\_\_
- 10) Are the inter-connecting wires and copper lines between indoor and outdoor units installed/covered/protected by line set covers, or anything else?
- 11) What is the refrigerant pipe length between each indoor unit and the outdoor unit? Unit A \_\_\_\_\_ Unit B \_\_\_\_\_ Unit C \_\_\_\_\_ Unit D...
- 12) Where is/are the indoor unit(s) located? Unit A \_\_\_\_\_ Unit B \_\_\_\_\_ Unit C \_\_\_\_\_ Unit D...
- 13) What is the elevation difference between each indoor unit and the outdoor unit? Unit A \_\_\_\_\_ Unit B \_\_\_\_\_ Unit C \_\_\_\_\_ Unit D... (indoor unit above outdoor unit +, below -)
- 14) Did you check the indoor unit for condensate leakage and refrigerant leakage, before and after connecting them?
- 15) Where is the outdoor unit located? Is the outdoor unit anchored to Ground wall balcony roof other ground or secured onto wall location or pad bracket?
- 16) Have you checked to make sure there is no cross-piping and no cross-wiring between any two indoor units (zones)? How did you do it, who was with you?
- 17) Were the refrigerant pipe ends capped or taped seal, prior to running them through structures to keep debris from entering the copper lines?
- 18) Have you checked and run cooling or heating, one unit by one unit, all working fine?
- 19) Did you charge the inter-connection copper pipes and indoor unit with nitrogen to check for positive leakage (pressures 150-200PSI), before conducting vacuuming leakage check?
- 20) Did you vacuum correctly to check the connecting pipes and indoor unit for leakage, what was the micron gauge reading, for how many minutes?
- 21) Did you check if the compressor can be started and stopped in a correct (design) manner?
- 22) If copper length were not made to the supplied or recommended refrigerant pipe length, how much refrigerant added or deducted?
- 23) Measured refrigerant pressures at outdoor service suction valve, when unit was st. Heat pump (PSI): \_\_\_\_\_ Cooling (PSI): \_\_\_\_\_ Outdoor Ambient Temp. (°F): \_\_\_\_\_
- 24) What were the measured temperatures (probe not touching any metal): At cooling: indoor return air °F, discharge air °F, and outdoor °F At heating: indoor return air °F, discharge air °F, and outdoor °F
- 25) Have you checked all unit functions, with customer's witness, and all functions are correct?
- 26) Did you show the user how to operate the unit? Did he/she understand you?
- 27) Do you provide regular one-year free technical service for this installation?
- 28) Do you list the working details in the invoice and leave a copy to the customer?

Installation Finished and Unit Works Successfully. Print Name of Installation HVAC Technician: Signature: _____ Date and time: _____	Installation Finished and Unit Works Successfully. Print Name of Owner: Signature: _____ Date and time: _____
---	--

By signing above, I acknowledge the liability and responsibility for any false statement or not telling all the facts, and I authorize YMGI to check the details of the filled above, and make its decision on warranty. I understand our filing or filling the warranty card/form DOESNT mean automatic warranty approval, because warranty is approved only to those qualified and successful installations by qualified HVAC technician. I know the warranty, if approved, is a standard 5-year compressor and 1-year other parts only, without any labor coverage. I agree to and will follow all the contents contained in the Limited Product Warranty Policy that YMGI, not other entity, stated in public, including but not limited to manuals, web site, email, etc.

Important Note: A copy of the installing HVAC company's invoice to show all their work details, your payment proof, center copy B of this registration card filled after a successful installation, all three (3) MUST be mailed together to Warranty Dept., YMGI Group, POB 1559, O'Fallon, MO 63366, for warranty processing. Customer keeps bottom copy C. YMGI will check against copy A that was kept at YMGI.



## CUSTOMER AND TECHNICIAN MUST READ

### PRIOR TO OPENING THE BOX OF, OR INSTALLING / SERVICING THE PRODUCT (HVAC & R)

Upon the purchasing, unpacking, installation and/or service of this product, you and all other parties hired to install or service your products, have read all YMGI Group (we) has written hereafter and all agree:

- 1) You understand all that is written hereafter in this and other documents that we publish.
- 2) You will follow what is written hereafter in this and other documents that we publish.
- 3) You will be bound by and completely follow all policies, guidelines, instructions, warnings, attentions and other materials, as published by YMGI Group, its subsidiaries or sister companies, in writing.
- 4) Only a successful installation, fully (100%) conducted by a qualified HVAC technician(s), as detailed in the checklist of the **Limited Product Warranty Policy** and **Limited Product Warranty Registration Card/Form**, along with a properly detailed installation invoice, is eligible for the **Limited Product Warranty**.
- 5) Failure to follow what is written hereafter may cause various equipment issues that you will take full responsibility and liability for, including, but not limited to, losing manufacturer's warranty, unit not working properly, unit malfunctions, under-performance, decreased safety, increased potential of various damages to your property, body, home and/or business, etc.
- 6) YMGI documents and policies supersede those made or provided by the sales distributors or installing contractors. YMGI Group maintains the final authority in explaining and resolving any and all discrepancies that might exist between distributors/contractors' documents and ours.

### YMGI STRONGLY RECOMMENDS:

- \* Customer hires a currently licensed/ certified HVAC technician(s) (N.A.T.E. or A.C.C.A certification is strongly recommended) to conduct 100% of the installation, inspection of all unit functions and repair service.
- \* Customer signs an installation/service contract with the installation/service technician's company who has good service references and you trust. Installation and service is very important to the life of your investment and provide you a lifetime of comfort and peace of mind.
- \* Customer requests the installer to put down a 1-year labor warranty coverage in the installation contract.
- \* Have the technician check against all the items in the checklist of the **Limited Product Warranty Registration Card/Form**, sign and date it, to help ensure a proper and professional installation.
- \* Customer pays in full, only after all the unit functions are inspected, the unit works properly, warranty checklist is fully filled out and signed and you are fully satisfied.
- \* If any unit abnormality is found, have your technician check the unit first. Have them call for manufacturer technical assistance, if necessary, from your job site, not his office, so that we can more accurately assist him in diagnosing the cause of the malfunction.

## CUSTOMER AND TECHNICIAN MUST READ

Dear Customer(s)/End User(s)/Unit Purchaser(s)/Installer(s)/Contractor(s)

Thanks for choosing YMGI products.

The YMGI equipment you purchased is either a split-type or a self-contained cooling/heating system which requires an installer's license, certification, knowledge, experience, carefulness and details for a successful and good installation. This equipment is different from those window or portable air conditioners you can normally purchase from local retail stores such as Home Depot, Lowe's, Sears, etc. which the manufacturer may not require licensed personnel to install.

Reading and following the YMGI Group recommendations, suggestions, and requirements, written in the following pages and other documents, is the first step in our hope and effort to help ensure a smooth installation & proper operation of your products for many years.

### WHY DOES YMGI GROUP REQUIRE INSTALLATION AND SERVICE TO BE PERFORMED BY LICENSED OR CERTIFIED HVAC TECHNICIAN/ CONTRACTOR?

- 1) They have the training and experience to accurately and safely install and service your equipment.**  
The equipment runs with high-pressure refrigerant and oil and line-voltage. The copper lines must be installed properly to prevent leakage and foreign substances from contaminating the refrigerant system.
- 2) You will save money in the long run.**  
If any problems occur on the unit that is fully installed by the licensed or certified contractor, they have the training and experience to correct the problem more efficiently. A technician(s) may be unwilling to repair an issue on a unit that they did not install. If you do find a technician willing to perform the service, there is an increased possibility of higher service fees than normal, increased service visits, or delayed service from that technician.
- 3) It's the law!**  
The federal, state and/or local government and authorities have various governing laws or regulations, guidelines, ordinances, etc., requiring only licensed or certified professionals can install and service high pressure HVAC equipment.

### SUGGESTIONS, TO AID YOU IN HIRING AN HVAC CONTRACTOR:

- 1) Hire a currently, practicing, licensed/ certified HVAC technician/ contractor. Technicians, who are no longer practicing (retired, etc.) in this field, may not have the updated knowledge or may lack experience on the equipment you have purchased.
- 2) Hire a technician/ contractor who services customers in your local area and you are familiar with. Local contractors have a faster response time and will be easier for you to determine if they are reputable.
- 3) Use only reputable licensed/ certified HVAC installation contractors/ technicians to prevent any unexpected charges as a result from unethical business practices.
- 4) Check their references, to verify they are a good service provider to the general customers. N.A.T.E or A.C.C.A certified technicians are strongly recommended.
- 5) Some contractors/ technicians may not feel comfortable about installing the equipment that you purchase for them to install, and they prefer to purchase and install the equipment. You can contact YMGI directly to check and see if there have been any contractors in your area who have installed our products or similar.
- 6) Ask for a detailed quote for the whole installation project. A flat rate quote is the safest contract for both you and the contractor
- 7) Your local HVAC technicians may charge you on a project basis or on an hourly basis. To our general knowledge and experience, **a full single head installation may normally cost anywhere from \$800 to \$1500**. These costs are estimates and your actual costs may differ due to job nature and location.
- 8) Number of hours can vary depending upon each individual situation, some factors are, but not limited to:
- 9) How difficult or complex the indoor unit is to be securely installed.
- 10) How difficult or how long the inter-connecting pipes and wires are to be installed.
- 11) If all the suggestions have been taken and all the necessary steps are followed.



## CUSTOMER AND TECHNICIAN MUST READ

- 12) If the contractor(s)/technician(s) are experienced with the systems/brands you purchase.  
**You might spend less. But remember, many times you get what you pay for.**
- 13) Sign a contract with them. The contract should list all the detailed work they will conduct and the standards they will follow. Some contractors are willing to include a 1-year installation/service warranty at no extra charge. Check with them to see if that is available. If available, include that in the contract.
- 14) Verify and confirm the installation is done completely and all the unit functions have been checked and are working properly, all the items in the checklist have been checked and marked well in the warranty registration card/form, prior to paying the contractor in full.

The cost of not having your unit installed properly can be more expensive than spending the little extra money that hiring the right contractor will cost. Protect your investment and warranty eligibility by doing it right the first time.

### THE FOLLOWING LISTS THE JOBS AND RESPONSIBILITIES OF THE TECHNICIAN/ CONTRACTOR:

- \* Performing a load calculation for the room(s) you would like to air condition. Cooling requirements will be different from the heating requirements. They will consider cooling hours, heating hours and your special needs or requirements. Supplemental heating such as baseboard heater or portable heater may help you save money by not over-sizing or under-sizing the heating equipment.
- \* Selecting the right type, size or model of cooling and/or heating equipment.
- \* Determining the best location to install the unit. (Positioning indoor unit, outdoor unit and running the inter-connecting pipes/wires.)
- \* Selecting the correct electrical components (HVAC circuit breaker or fuse and disconnect switch for the electric power to the outdoor unit, types and sizes of the connecting wires between circuit breaker/disconnect switch and outdoor unit, and the wires between outdoor unit and indoor unit).
- \* Keeping the indoor unit away from the ceiling and the outdoor unit away from the wall, bushes and other obstacles at a proper and safe distance to allow for the proper airflow through the unit's.
- \* Placing the units on a secured level structure.
- \* Taping and sealing both ends of the inter-connecting pipes, before running them through structures, to prevent dust or other debris from getting into the pipes otherwise they will contaminate and damage the refrigeration system. Failure to follow this practice will make your factory warranty void.
- \* Connecting the inter-connecting pipes between the outdoor and indoor units. Checking for leaks through pressurization with nitrogen. After releasing nitrogen, evacuate the piping and indoor unit, for removal of system contaminants. Finally refrigerant introduction and adjustment, if necessary, from the outdoor unit.
- \* Back-seating the stopping valves at outdoor condensing unit to release pre-charged refrigerant from outdoor unit to indoor unit.
- \* Measuring and recording the electrical voltages at different terminals and the refrigerant pressures at stopping valves of outdoor condensing unit.
- \* Verifying and ensuring the unit is connected to the proper electrical power supply.
- \* Adjusting refrigerant levels (if necessary) following the installation instructions or chart on the unit.
- \* Checking for any unusual noises and other abnormalities that might be present.
- \* Operating the unit and check all functions, one by one, and explain to the owner how to operate and maintain the unit.
- \* Completing all fields in detail on the installer checklist, signing and dating the **Warranty Registration Card/Form**.

### LIMITED PRODUCT WARRANTY

If the installation is successfully and fully done by a qualified licensed/ certified HVAC technician/contractor, the registration card/form is filled completely and correctly, and filed along with a valid installation invoice from the contractor company within 7 days of the original installation, the following standard **Limited Product Warranty** is qualified:

5-year on compressor and 1-year other PARTS ONLY. There is **no labor coverage**.

## CUSTOMER AND TECHNICIAN MUST READ



### ATTENTION

- 1) The YMGI **Limited Product Warranty Policy**, details the eligibilities, coverage's and other explanations of the warranty terms between YMGI group and the unit owner.
- 2) The YMGI **Limited Product Warranty Policy** and the **Warranty Registration Card/Form** are either included inside the user's manual and/or installation instruction manual, or come separately in the unit packaging box/envelope. If for any reason they are not included with your shipment, contact our sales or customer service to request a copy (electronic or printed), prior to installation.
- 3) The checklist, in the **Warranty Registration Card/Form**, is for the currently licensed/ certified HVAC technician to fill out completely, while verifying all unit functions are operating correctly. This checklist is for the technician to test and check all details of your unit, to verify and ensure its proper operation.
- 4) The technician must complete all fields in the **Warranty Registration Card/Form**, especially the unit model and serial numbers and distributor information, and most importantly, the technician checklist.
- 5) **Warranty Registration Card/Form** shall be mailed, **along with the original copy of the currently licensed HVAC contractor's full installation invoice**, to YMGI Group, within 7-days after original installation, in order for YMGI to review and process your warranty registration.
- 6) Keep a copy of **Warranty Registration Card/Form** for your own use in the future, to aid in any possible future warranty claiming, any request of parts, customer service, and/or technical support.
- 7) YMGI reserves the right to approve or deny the warranty status based on the information reviewed.

Mailing address of the **Warranty Registration Card/Form**: Warranty Department, YMGI Group, POB 1559, O'Fallon, MO 63366, USA.

Following these requirements will aid in ensuring the units will be installed to the general HVAC practicing standards and are necessary factory requirements, to find problems early, prevent possible damage to the unit and help ensure the unit will work properly for its life time.

### QUESTIONS ABOUT SELF-INSTALLATION VS HIRING LICENSED HVAC TECHNICIANS

Does YMGI allow to do-it-yourself installations (DIY) partially or fully? NO.

Unfortunately no brand or manufacturer can take the responsibility of the equipment if it is not professionally installed by a currently licensed HVAC technician/ contractor.

If unit is installed by non-licensed people, in part or fully, will the factory warranty be void? YES.

Some DIY installations have been successful, but these are exceptions. Most have resulted in equipment failure, due to lack of knowledge and experience. A few of the problems result from DIY's lack of knowledge in the following areas:

- \* Sizing and selecting correct type, size and model of cooling and/or heating equipment.
- \* Sizing and installing correct electric circuit breakers and wires.
- \* Wiring the units correctly and properly.
- \* Taping the ends, connecting to indoor and outdoor units correctly and properly.
- \* Vacuuming the inter-connecting refrigerant lines.
- \* Checking and/or fixing the refrigerant leaks.
- \* Checking and/or fixing the condensate drain leaks.
- \* Releasing the refrigerant from outdoor unit to indoor unit.
- \* Running the unit to check all the unit functions.
- \* Conducting the installation or trouble-shooting with correct tools, experience or professional knowledge to correct the problem.

### RECEIVING AND FREIGHT DAMAGE

- \* Freight (package/unit) shall be checked thoroughly for damage at receiving before accepting by signing on the carrier's delivery paperwork.
- \* Upon shipment being signed for acceptance, it becomes a binding document as to the condition of the products on delivery. We cannot process any shipping damage claim, if you accept the delivery.
- \* If damage is found at delivery, both you and the delivery driver must make notes on the delivery receipt or other freight paperwork detailing the damage found by marking position/parts on unit, description of damage, time/ date, your name, contact phone, etc. on the delivery documents. Make a copy of the marked delivery receipt.

## CUSTOMER AND TECHNICIAN MUST READ

- \* If the damage is minor or partial, that you choose to accept, you can contact the distributor or YMGI to discuss the possible replacement of the damaged part.
- \* If refusal of the shipment is needed due to severe freight damage, **DO NOT** sign the carrier's delivery receipt document indicating that you accept the products. Mark receipt "REFUSED DUE TO FREIGHT DAMAGE." Sign and date along with the delivery driver's signature and date.
- \* Take pictures showing the damage, before the delivery driver leaves.
- \* If you accept the delivery or fail to note damage on the driver's delivery receipt, the ability to claim freight damage is lost and YMGI will not replace the unit on this basis.
- \* Contact the distributor or YMGI, report the damage by forwarding the marked delivery receipt copy and pictures.
- \* Only after YMGI verifies with the carrier the necessary detailed notes of received freight damage, will the damaged products be eligible for replacement.
- \* If the returned products are found not damaged, YMGI will treat it as a return and will charge you 25% of product value plus added shipping cost.

### RETURN-YMGI GROUP POLICIES & RETURN GOODS AUTHORIZATION (RGA)

All sales are final. If the customer wishes to return a product, the following **Return Policies** apply.

A. Only those products (units, parts or accessories) under the following conditions, are eligible for return:

**1) Products are returned within 30 days of their original shipment date from YMGI**

- 2) Products have not been installed.
- 3) No damage exists on the products being returned.
- 4) No missing products.
- 5) Products and packages are clean.
- 6) No duct tape or marking on the product or box.
- 7) Products are still their original package, in good shape and in re-sellable condition, as YMGI determines.

B. Preapproval steps for your return request:

- 1) Contact your distributor or YMGI to request a return.
- 2) Photograph your product and box to show details
- 3) YMGI will review your request, along with the pictures and any other details pertaining to your request.
- 4) If YMGI agrees to process your return request, a form called **Return Goods Authorization (RGA), along with an assigned RGA #** will be forwarded to your distributor or you.
- 5) Any return without YMGI Group approved RGA#, will not be accepted.

C. YMGI must verify the following before you can pack your products:

- 1) No products (units, parts, accessories) are missing.
- 2) No damage is found.
- 3) The products are in the original packaging.
- 4) No duct tape on any product or box.
- 5) Pictures have been taken and sent to YMGI to verify the product and boxes are not damaged.
- 6) The RGA has been completed and a copy has been returned to YMGI, via email or fax.
- 7) YMGI has approved the request in writing.

D. Shipping Preparation:

- 1) Package all products in a manner in which no damage can occur to the product and secure to a pallet.
- 2) Take and forward pictures of packed pallets for YMGI to verify proper packaging and no existing damage.
- 3) Include the YMGI approved RGA# in the shipping documents.
- 4) YMGI reserves the right to approve or deny any shipments.
- 5) YMGI can arrange shipping for you, but not at YMGI's cost. If this option is chosen, a packing list and BOL will be issued to you through YMGI.
- 6) If the above option is not chosen, you will be responsible for all freight charges. YMGI will not accept any returned items COD.
- 7) Place the package in an area which is accessible to the shipping company for pickup and limits the possibility of damage to the product. Customer must be present at the time of freight pick up.

After shipping, fax the BOL to YMGI Group at 1-866-377-3355 or email to [customerservice@ymgigroup.com](mailto:customerservice@ymgigroup.com), detailing the information of the freight company and their tracking number.

E. Freight Damage:

- 1) YMGI Group will inspect returned items
- 2) Claiming of freight damage from a customer hired carrier will be the customer's responsibility.
- 3) Claiming of freight damage from a YMGI hired carrier will be YMGI's responsibility.

## CUSTOMER AND TECHNICIAN MUST READ

F. Charges for your return:

- 1) A restocking charge of 25% creditable invoice value.
- 2) All return shipping fees.
- 3) Additional fees will be charged, if products are found to be damaged, missing or used.
- 4) YMGI will notify the distributor of the charges only after the inspection and assessment of the returned products has been completed.

**Attention:**

- 1) Returned products must be shipped within 7 days of YMGI's releasing of **RGA #**.
- 2) **All RGA** shipping shall be prepaid by the customer. **YMGI will not accept any COD freight.**

**YMGI GROUP DISCLAIMING-1:**

YMGI Group will NOT accept any return, or may not honor 100% credit for any return of Product(s)/Part(s)/Accessories, in any of the following cases:

- \* Return requests made 30 or more days after the date of original sales shipping from YMGI Group warehouse.
- \* Return shipment is initiated 8 days or more after the RGA is approved.
- \* Returned products received not displaying an YMGI-approved valid **RGA #**.
- \* Returned products received C.O.D.
- \* Returned products not received in the original packaging.
- \* Returned products received with non-repairable packaging, including duct tape or marks on units or carton boxes.
- \* Returned products received with missing units/parts/accessories.
- \* Returned products received, are found to be non-functional or damaged.

**YMGI GROUP DISCLAIMING-2:**

- \* YMGI Group will not be responsible for any losses of returned unit(s)/part(s)/accessories in transition to YMGI Group warehouse.
- \* YMGI Group RGA is valid for seven (7) days from the original issuing date. Returns will not be accepted, if shipping is made 8 or more days after the YMGI Group RGA is issued.

### DEFECTIVE UNITS / PARTS / ACCESSORIES-REPAIR OR REPLACEMENT

Out of thousands of units sold every year, there may be an occasional instance your product does not operate properly. Reasons of but are not limited to: **manufacturing, installation, operation, maintenance and knowledge of operator.**

Equipment failure does not automatically denote a product defect from the factory assembly line. The defects can be caused, during production, transportation, installation, operation, maintenance, or service. Defects may NOT be the responsibility of the manufacturer. Nobody willfully or intentionally produces a defective product. No determination shall be made until the technical issue(s) or the causes of the defect(s) are identified.

The defects might be found before/ during installation or in the operation of the unit. Defects can be in the form of blown fuse(s), defective control board(s), damaged remote control, loose or missing screws, etc. These defective parts can be replaced easily.

Some functions of our units are different from what are typical in traditional split type air conditioning and heat pump systems and similar systems made by other manufacturers. These are not defects. Take some time to learn the functions of your unit. We will be happy to assist you with any questions you may have concerning the functions of your new unit.

If a defect is found, whether at the original installation, or during normal operation, we will gladly help you in the following steps in sequence from 1 to 3:

1. **Part repair or replacement after trouble-shooting:** This is the most common and generally the easiest and most economical way for all parties, since the problem and all part needs can be accurately and completely identified.

- \* Your technician calls our technical support line, from your job site, after checking your units and getting all the information ready.
- \* Our technical support will go through several steps, over the phone or through email, with your technician, in order to help identify and resolve the problems. Normally wiring correction, piping correction, part repair/ replacement will resolve the problems.



## CUSTOMER AND TECHNICIAN MUST READ

\* Your technician will then need to verify and confirm the problem(s) before YMGI can ship out the replacement part(s). Inaccurate or incomplete troubleshooting or part replacement will delay the repair. YMGI technical support will only speak with a licensed/certified technician in regards to the repair of your unit. In our experience this saves time and money for all parties involved.

Your technician is the only person to perform any physical checking, trouble-shooting and replacing of any defective part(s) for your units. Our factory technical support is just a help. **YMGI provided no labor warranty on the products.**

**2. Unit/part repair at our workshop(s):** Due to the limitations of our technical support not being at your job site, or your technician's experience with our product, the problem may not be resolved as quickly as would be desired. If the problem is still not resolved after attempts between your technician and our technical support, you can elect to have the unit repaired at our facility. If this step is chosen:

- 1) YMGI will send to you the **Customer Request to Ship Products to YMGI Service Center for Inspection and Repair, and Authorization to Charge** form.
- 2) You will review the form and fill all fields appropriately, sign and send back to the YMGI Group.
- 3) Once the form has been completed and sent back to YMGI, remove the units and ship back to YMGI.

Please make a note describing the problem and communication history, if possible. Our technicians will check the units and find the problem(s), repair the issue(s), and ship the unit back to you following the conditions set forth in the signed repair agreement. All unit removal and re-installation is done at your cost and must be done by a currently valid licensed HVAC technician.

**3. Unit replacement:** Only applies to those defects reported within 30 days of original purchase date and if all necessary warranty paperwork had been received and approved. This option applies only if the above steps cannot resolve the problem(s). Either indoor or outdoor unit replacement is available, based on the actual need, at YMGI's determination. **This option shall be the last resort**, due to refrigerant and wiring considerations. All unit removal, re-installation and shipping cost are the responsibility of the customer. YMGI maintains the final authority as to unit replacement. Replacement will be made with the same model only. Alternate units will be treated as a new order.

**Returning Replaced Defective Units/Parts/Accessories After Unit Repair:** (Only applies to steps 1&3 above)

- 1) Repack the replaced unit/ part /accessory in the box which contained the replacement part.
- 2) Parts can be boxed for UPS, FedEx or equivalent ground service. Units shall be secured onto the skid on which the replacement was shipped after placing into the package from the replacement product.
- 3) Ship **all** replaced products, to YMGI-designated location. You will be charged if YMGI does not receive the replaced parts.

Standard factory warranty does not cover the cost of materials and labor that are incurred at your site. There will be no cost for the replacement unit, if YMGI determines the defect is manufacturer related. Replacement will be made with the same model, only. Alternate units will be treated as a new order.

## CUSTOMER SERVICE / TECHNICAL SUPPORT FROM YMGI GROUP

For questions or help with your unit, contact the original installer or service provider.

YMGI Group does not install nor physically service your unit. Your installer or service provider must check the unit prior to contacting YMGI Group from your jobsite, in order to be helped in an efficient and timely manner.

\* Factory customer service at [customerservice@ymgigroup.com](mailto:customerservice@ymgigroup.com) Tel: 1-866-833-3138x704

\* Factory technical support at [techsp@ymgigroup.com](mailto:techsp@ymgigroup.com) Tel: 866-833-3138x703

\* Fax: 1-866-377-3355

An "**YMGI Group Customer Service/Technical Support Daily Log Sheet**" will be filed in writing at our office, for effective communication between you and YMGI Group customer service, your technician and YMGI Group technical support. Before contacting the YMGI Group locate the IP# written at the top of your warranty registration form. Use this IP# whenever you contact the YMGI Group.



## DISTRIBUTOR AND MANUFACTURER POLICIES



- \* All questions concerning sales or money will be directed to the sales distributor from which you purchased the units.
- \* Read and follow all policies set forth from the distributor from which you purchased your unit.
- \* Upon purchase and installation of the unit(s), you agree to be bounded by all policies published by both distributors and YMGI.
- \* MGI Group has the final authority and supersedes other related parties (distributors, etc.) concerning all policies regarding YMGI products.

## IMPORTANT NOTES

### SAFETY WARNINGS

**READ THESE SAFETY WARNINGS COMPLETELY PRIOR TO ANY USE.**

	Ground connection
	Disconnect the plug

	Forbidden
	Imperative

These precautions are essential and must be strictly observed.

**DO NOT** draw on the power cord or refrigeration lines. Install them in secured positions. Plastic cover of line set is recommended.



**DO NOT** use smaller than enough wires. Do not put several circuits to one breaker. Don't use smaller than enough circuit breakers. Otherwise power failure or fire may be caused.

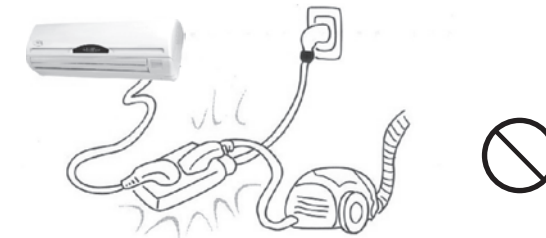

**DO NOT** pull on the power cord or refrigeration lines. Install them in a secured position. A line set plastic cover is recommended.

**DO NOT** install the unit in places where there is exposure to flammable materials or gas leakage.

**DO NOT** use wire or circuit breakers that do not meet electrical safety standards. Several circuits cannot be connected to one breaker.

**DO NOT** wire or open the unit while it is running. Make sure to shut off all circuits prior to inspecting or servicing the unit.

**DO NOT** install unit in a damp laundry room or near flammable gas. All units must be protected by certified electrical circuit breakers and in accordance with all safety codes.

**DO NOT** use the unit in cool or dry mode for prolonged periods where humidity is higher than 80%.

**DO NOT** blow the cold air directly towards people for prolonged period. Otherwise, people may get cold.

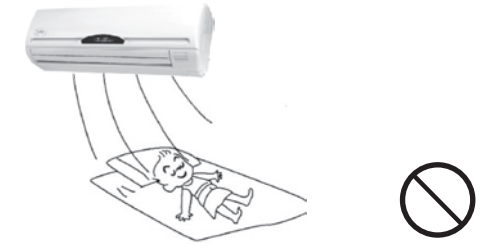

**DO NOT** wire or open unit while unit is running. Sparks or fire may occur. It may cause a shock to people.

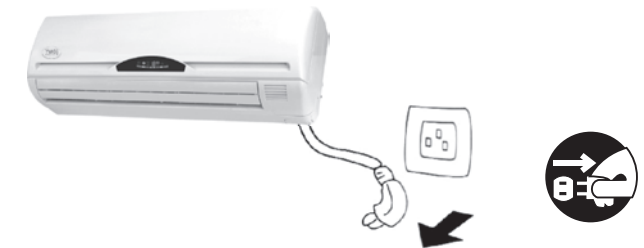

**DO NOT** install the indoor unit close to cooking surfaces or ventilation systems. Poor placement could inhibit peak performance.

**DO NOT** blow cold air directly towards people for extended periods. It may get you a bad cold.

**DO NOT** use chemical solvents, flammable insecticides, or abrasive materials. Clean the unit only with a soft dry cloth or rag.

**DO NOT** continue to operate the unit if there is any abnormal odor, burning, scorching, or smoke. Stop and disconnect the unit immediately.

**DO NOT** use the system for anything other than what it was designed for or any non-HVAC purposes. Do not store near food, paint, or other chemicals.

**DO NOT** operate the unit for prolonged periods without refreshing ambient air. Opening a door or window periodically will suffice.

## SAFETY-ATTENTIONS

Clean the unit with a soft cloth or dry rag. Do not use chemical solvents, flammable insecticide, sprays or the likely products to clean the unit. Otherwise, damage to the unit may be incurred.



Do NOT install the indoor unit close to cooking or ventilation. Otherwise, unit efficiency will be affected seriously.



Stop and disconnect the unit immediately after finding the unit at anomaly order (burning, scorching...)

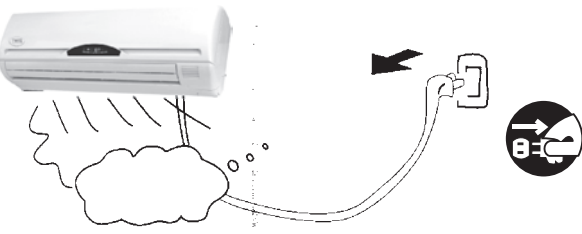

Close doors and windows. If you use the unit for a prolonged period and the ambient air turns to be unpleasant, open a door or a window for a moment to refresh the atmosphere.

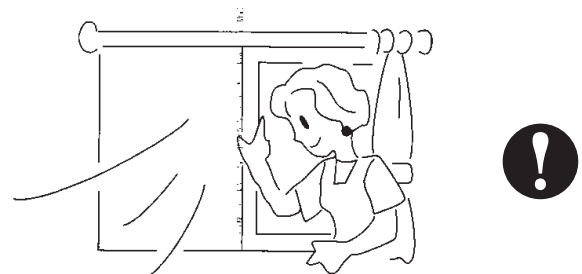

Intall the unit in accordance with all the safety codes applied. The unit cannot be installed in a wash-house or where flammable gas could occur. The unit must be electrically protected by qualified circuit breakers.



Do NOT install the unit in places at risk of farmable gas leakage. If electric spark is incurred in the unit accidentally, it could cause a fire or an explosion.

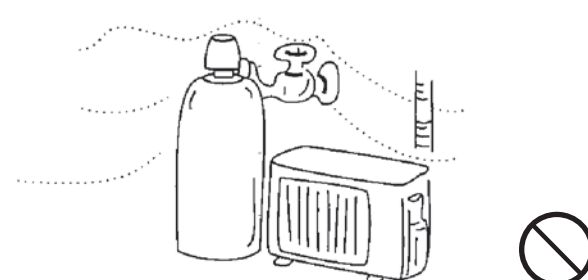

Do NOT use the system for other non-HVAC purpose. Do not store it along with food or painting or other chemicals.

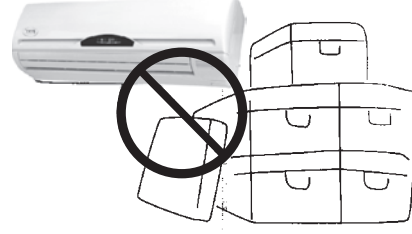

Do NOT use the unit in cool/dry during a prolonged period at high moisture (higher than 80%). Condensation could be formed on the indoor unit casing if a door or window is open or the indoor humidity is high.



## BRIEF INTRODUCTION TO MINI SPLIT WALL MOUNT SYSTEM

Mini Split Wall Mount Systems are designed for high performance, easy installation and service. Each system consists of one or several indoor units and one outdoor unit, which are connected by one set or several multiple sets of interconnection refrigerant pipes and electric wires.

As shown in the following sample picture of outdoor unit, air is drawn through the coil from the rear side and then discharged from the front side. In cooling mode, air passing through coil is cooled; in heating mode, air passing through coil is heated.

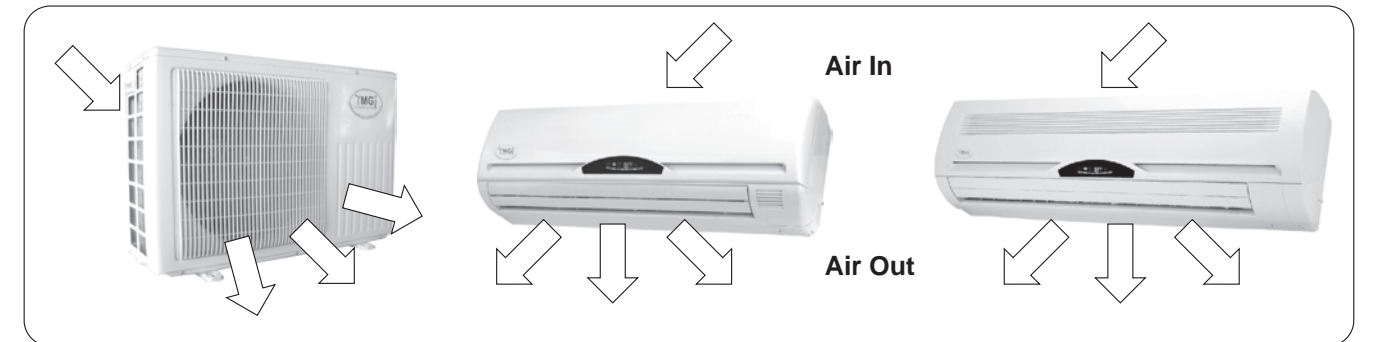

**Sample Wall Mount Mini Split System (For Continuous Engineering Improvement and Various Marketing Needs and Actual Part Availability Reason, Unit Appearance Subject to Change or Update Continuously without Prior Notice)**

Outdoor unit(s) provides the electrical and thermal power for the whole system. Electrical and thermal components such as compressors and motors and heat exchange coils and others, are incorporated into the cabinet in an optimized order. They can be either hung on the wall or installed on the ground. Once stacking or bracket kit is used, some outdoor units can be stacked 2 or 3 units high, upon unit size and applications. Air is discharged horizontally, quietly and smoothly. These units are perfect fit in locations where installation and applications of general up-flow condensing units are limited, such as apartments, condos, lofts, multi-families and high-rise buildings and others named or unnamed.

Indoor unit(s) delivers the thermal and acoustical comfort to the rooms. Air is drawn through the coil from the front or topside and then discharged from the bottom. In cooling mode, air passing through coil is cooled; in heating mode, air passing through coil is heated. Air is filtered or treated by the built in mechanism (washable or enzyme equipped or electrostatic powered filter, varies from model to model), before being delivered into the room, with more than enough comfort and care, at a wide angle (swing or not, varies from model to model).



Apartments



Office Buildings



Homes

### Application Samples of Wall Mount Mini Split Systems

**NOTES:** Since ductless system is not designed to incorporate or use with ducted return or discharge tunnels, one single-zone unit SHALL NOT be used to take care of the cooling or heating load of more than one-story room. Several single-zone ductless systems or multiple-zone ductless systems shall be proper in this regard.

**These units are designed for applications at:**

- \* Residential
- \* Institutional
- \* Commercial
- \* Light commercial
- \* Industrial
- \* Hospital



## MINI WALL MOUNT SYSTEMS-MODELS

### Wall Mount Mini -Basic Split Systems-Single & Multiple Zones

13 SEER

R410A

#### Wall Mount Mini Split - Single Zone

Cooling Only	System Model	WMMS-09K-31A(B)	WMMS-12K-31A(B)	WMMS-18K-31B	WMMS-24K-31B	WMMS-30K-31B	WMMS-36K-31B
	Indoor Unit	WMMS-09E-31A(B)	WMMS-12E-31A(B)	WMMS-18E-31B	WMMS-24E-31B	WMMS-30E-31B	WMMS-36E-31B
	Outdoor Unit	WMMS-09C-31A(B)	WMMS-12C-31A(B)	WMMS-18C-31B	WMMS-24C-31B	WMMS-30C-31B	WMMS-36C-31B
Heat Pump	System Model	WMMS-09K-32A(B)	WMMS-12K-32A(B)	WMMS-18K-32B	WMMS-24K-32B	WMMS-30K-32B	WMMS-36K-32B
	Indoor Unit	WMMS-09E-32A(B)	WMMS-12E-32A(B)	WMMS-18E-32B	WMMS-24E-32B	WMMS-30E-32B	WMMS-36E-32B
	Outdoor Unit	WMMS-09C-32A(B)	WMMS-12C-32A(B)	WMMS-18C-32B	WMMS-24C-32B	WMMS-30C-32B	WMMS-36C-32B
Heat Pump / Elec. Heat	System Model	WMMS-09K-34B	WMMS-12K-34B	WMMS-18K-34B	WMMS-24K-34B	WMMS-30K-34B	WMMS-36K-34B
	Indoor Unit	WMMS-09E-34B	WMMS-12E-34B	WMMS-18E-34B	WMMS-24E-34B	WMMS-30E-34B	WMMS-36E-34B
	Outdoor Unit	WMMS-09C-32B	WMMS-12C-32B	WMMS-18C-32B	WMMS-24C-32B	WMMS-30C-32B	WMMS-36C-32B

#### Wall Mount Mini Split - Dual Zone

Cooling Only	System Model	WMMS-2X09K-31B	WMMS-0912K-31B	WMMS-2X12K-31B	WMMS-2X18K-31B	WMMS-2X24K-31B	WMMS-2X30K-31B
	Indoor Unit	WMMS-09E(F)-31B	WMMS-0912E(F)-31B	WMMS-12E(F)-31B	WMMS-18E(F)-31B	WMMS-24E(F)-31B	WMMS-30E(F)-31B
	Outdoor Unit	WMMS-2X09C-31B	WMMS-0912C-31B	WMMS-2X12C-31B	WMMS-2X18C-31B	WMMS-2X24C-31B	WMMS-2X30C-31B
Heat Pump	System Model	WMMS-2X09K-32B	WMMS-0912K-32B	WMMS-2X12K-32B	WMMS-2X18K-32B	WMMS-2X24K-32B	WMMS-2X30K-32B
	Indoor Unit	WMMS-09E(F)-32B	WMMS-0912E(F)-32B	WMMS-12E(F)-32B	WMMS-18E(F)-32B	WMMS-24E(F)-32B	WMMS-30E(F)-32B
	Outdoor Unit	WMMS-2X09C-32B	WMMS-0912C-32B	WMMS-2X12C-32B	WMMS-2X18C-32B	WMMS-2X24C-32B	WMMS-2X30C-32B
Heat Pump / Elec. Heat	System Model	WMMS-2X09K-34B	WMMS-0912K-34B	WMMS-2X12K-34B	WMMS-2X18K-34B	WMMS-2X24K-34B	WMMS-2X30K-34B
	Indoor Unit	WMMS-09E(F)-34B	WMMS-0912E(F)-34B	WMMS-12E(F)-34B	WMMS-18E(F)-34B	WMMS-24E(F)-34B	WMMS-30E(F)-34B
	Outdoor Unit	WMMS-2X09C-32B	WMMS-0912C-32B	WMMS-2X12C-32B	WMMS-2X18C-32B	WMMS-2X24C-32B	WMMS-2X30C-32B

#### Wall Mount Mini Split - Triple Zone

Cooling Only	System Model	WMMS-3X09K-31B	WMMS-3X12K-31B	WMMS-2X0912K-31B	WMMS-2X1218K-31B	WMMS-2X1824K-31B	WMMS-1230K-31B
	Indoor Unit	WMMS-09E(F)-31B	WMMS-09E(F)-31B	WMMS-0912E(F)-31B	WMMS-1218E(F)-31B	WMMS-1824E(F)-31B	WMMS-1230E(F)-31B
	Outdoor Unit	WMMS-3X09C-31B	WMMS-3X12C-31B	WMMS-2X0912C-31B	WMMS-2X1218C-31B	WMMS-2X1824C-31B	WMMS-2X1230C-31B
Heat Pump	System Model	WMMS-3X09K-32B	WMMS-3X12K-32B	WMMS-2X0912K-32B	WMMS-2X1218K-32B	WMMS-2X1824K-32B	WMMS-2X1230K-32B
	Indoor Unit	WMMS-09E(F)-32B	WMMS-09E(F)-32B	WMMS-0912E(F)-32B	WMMS-1218E(F)-32B	WMMS-1824E(F)-32B	WMMS-1230E(F)-32B
	Outdoor Unit	WMMS-3X09C-32B	WMMS-3X12C-32B	WMMS-2X0912C-32B	WMMS-2X1218C-32B	WMMS-2X1824C-32B	WMMS-2X1230C-32B
Heat Pump / Elec. Heat	System Model	WMMS-3X09K-34B	WMMS-3X12K-34B	WMMS-2X0912K-34B	WMMS-2X1218K-34B	WMMS-2X1824K-34B	WMMS-2X1230K-34B
	Indoor Unit	WMMS-09E(F)-34B	WMMS-09E(F)-34B	WMMS-0912E(F)-34B	WMMS-1218E(F)-34B	WMMS-1824E(F)-34B	WMMS-1230E(F)-34B
	Outdoor Unit	WMMS-3X09C-32B	WMMS-3X12C-32B	WMMS-2X0912C-32B	WMMS-2X1218C-32B	WMMS-2X1824C-32B	WMMS-2X1230C-32B

#### Wall Mount Mini Split - Quad Zone

Cooling Only	System Model	WMMS-4X09K-31B	WMMS-4X12K-31B	WMMS32X0912K-31B	WMMS-3X1209K-31B	WMMS-2X(0912)K-31B
	Indoor Unit	WMMS-09E(F)-31B	WMMS-12E(F)-31B	WMMS-0912E(F)-31B	WMMS-12/09E(F)-31B	WMMS-09/12E(F)-31B
	Outdoor Unit	WMMS-4X09C-31B	WMMS-4X12C-31B	WMMS-3X0912C-31B	WMMS-3X1209C-31B	WMMS-2X(0912)C-31B
Heat Pump	System Model	WMMS-4X09K-32B	WMMS-4X12K-32B	WMMS-3X0912K-32B	WMMS-3X1209K-32B	WMMS-2X(0912)K-32B
	Indoor Unit	WMMS-09E(F)-32B	WMMS-12E(F)-32B	WMMS-0912E(F)-32B	WMMS-12/09E(F)-32B	WMMS-09/12E(F)-32B
	Outdoor Unit	WMMS-4X09C-32B	WMMS-4X12C-32B	WMMS-3X0912C-32B	WMMS-3X1209C-32B	WMMS-2X(0912)C-32B
Heat Pump / Elec. Heat	System Model	WMMS-4X09K-34B	WMMS-4X12K-34B	WMMS-3X0912K-34B	WMMS-3X1209K-34B	WMMS-2X(0912)K-34B
	Indoor Unit	WMMS-09E(F)-34B	WMMS-12E(F)-34B	WMMS-0912E(F)-34B	WMMS-12/09E(F)-34B	WMMS-09/12E(F)-34B
	Outdoor Unit	WMMS-4X09C-32B	WMMS-4X12C-32B	WMMS-3X0912C-32B	WMMS-3X1209C-32B	WMMS-2X(0912)C-34B

#### IMPORTANT NOTES-About System Performance:

- 1) The rated performance data is tested under one of the indoor & outdoor conditions at standard set-up installation.
- 2) Actual performance varies upon many factors such as indoor and outdoor temperatures, inter-connecting pipe length/bending, elevation difference between indoor and outdoor units, refrigerant level, vacuum level, leakage, air or moisture or other contamination level, foreign substance left in the piping, indoor filter cleanliness, indoor and outdoor coil conditions, and others.
- 3) The electrical driving voltage and frequency, as well as the mechanical performing pressures and temperatures, at different operating points, during different operating periods, at different operating conditions. Suggest to measure temperatures and pressures several minutes after starting, when unit is stabilized.
- 4) May refer to other specification tables or engineering submittals, for detailed system performance at different conditions.
- 5) System performance will be degraded, if systems are improperly selected, operated, installed, maintained, or serviced (which are not conducted by manufacturer).

## SYSTEM COMPONENTS-GENERAL

### INDOOR UNIT

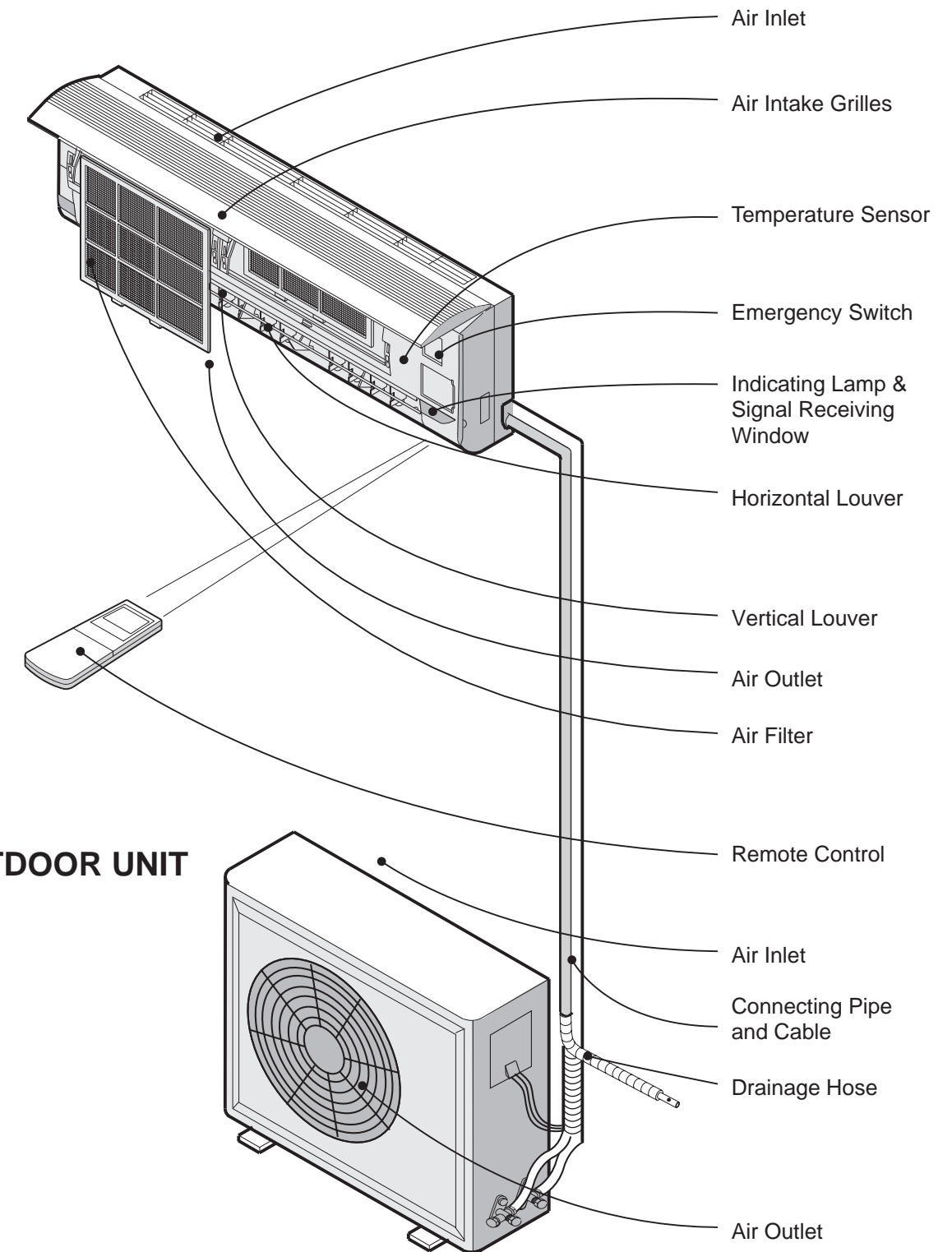

### OUTDOOR UNIT

The figures in this manual are based on the external view of a standard model. Consequently, the shape or appearance may differ from that of the air conditioner you have selected.

## SYSTEM COMPONENTS & INSTALLATION CLEARANCE: SINGLE ZONE

### CLEARANCE REQUIRED AROUND UNITS-SINGLE ZONE

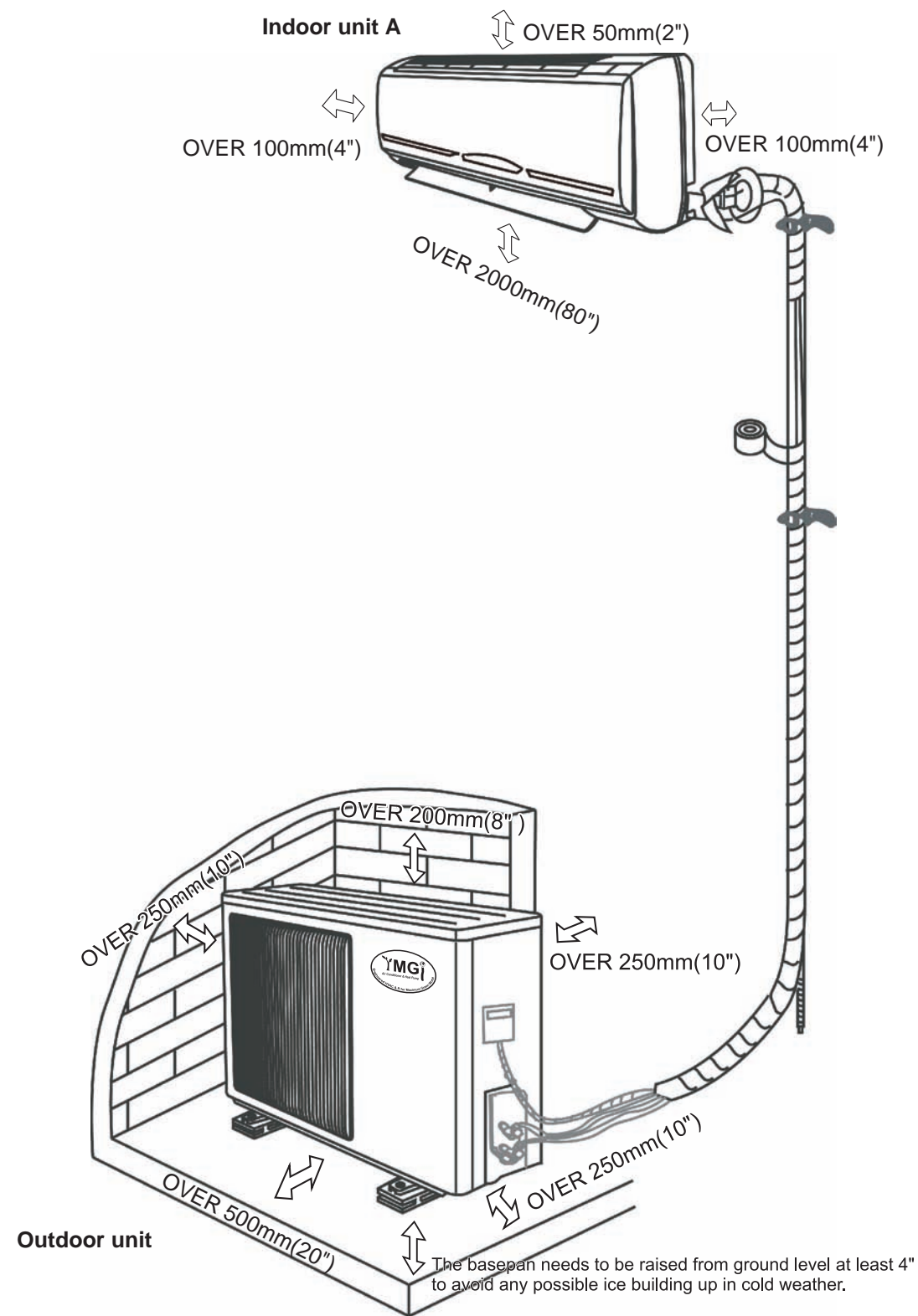

INSTALLER'S INSTRUCTION

## SYSTEM COMPONENTS & INSTALLATION CLEARANCE: DUAL ZONE

### CLEARANCE REQUIRED AROUND UNITS-DUAL ZONE

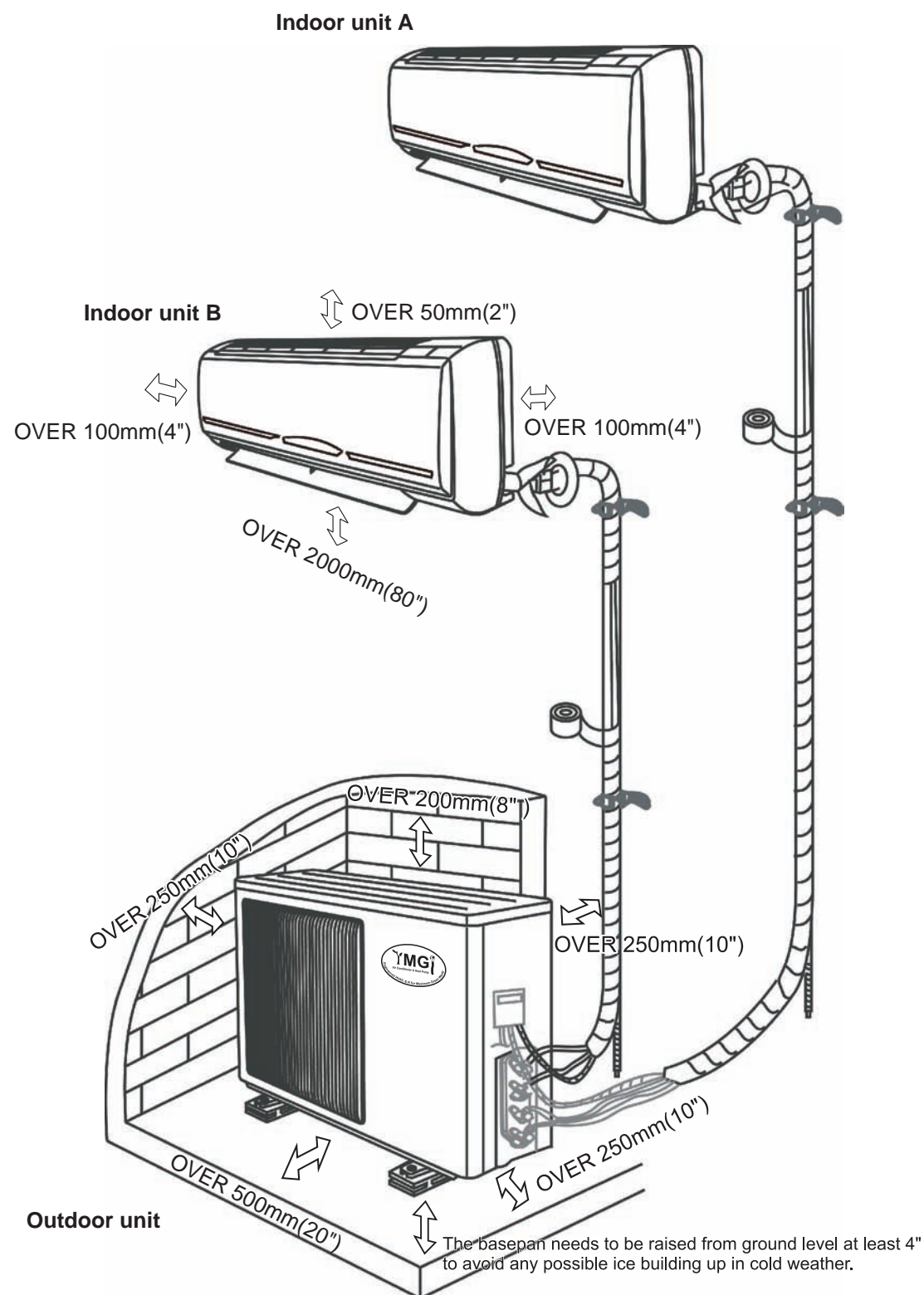

INSTALLER'S INSTRUCTION

## SYSTEM COMPONENTS & INSTALLATION CLEARANCE: TRIPLE ZONE

### CLEARANCE REQUIRED AROUND UNITS-TRIPLE ZONE

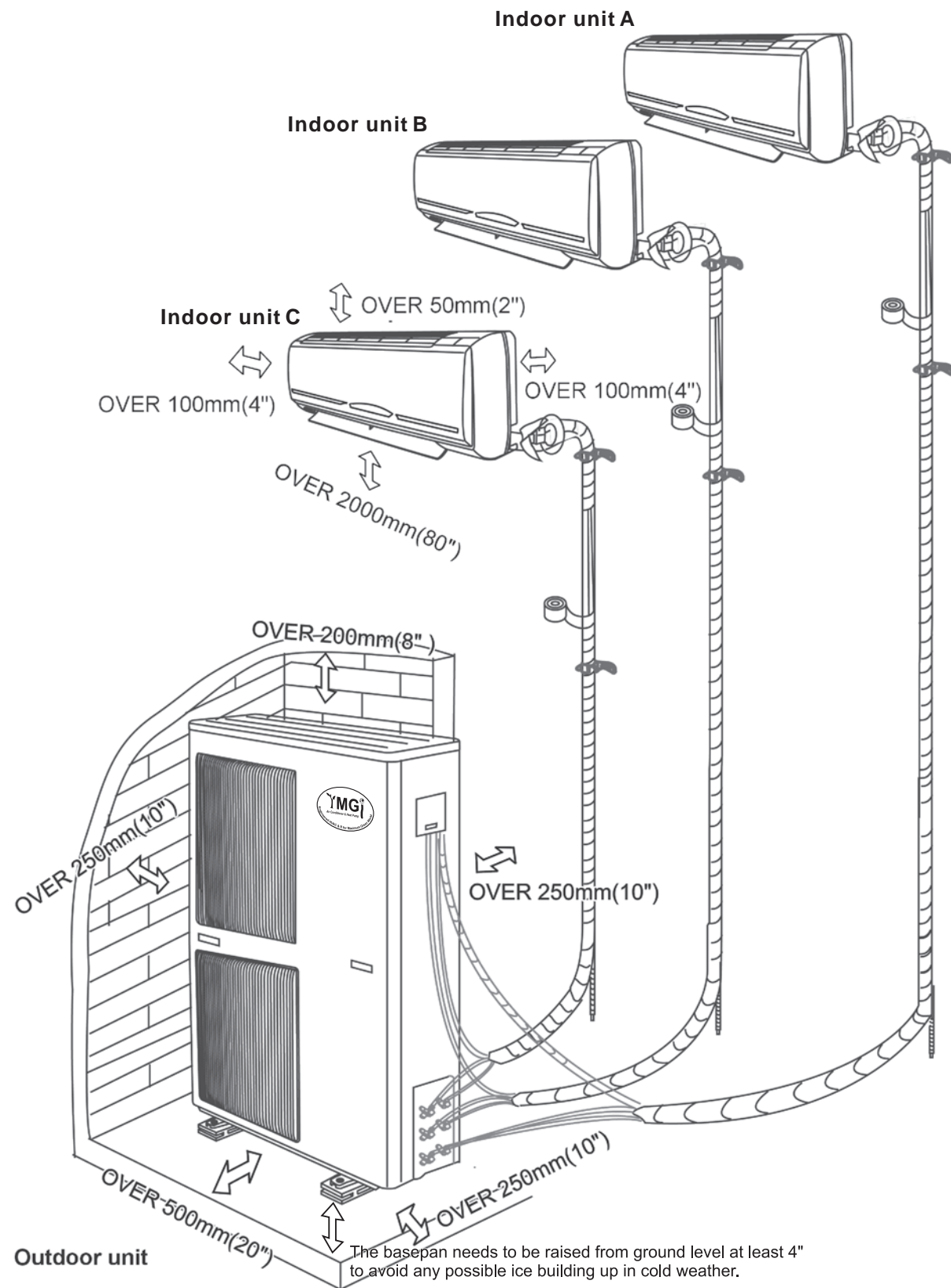

INSTALLER'S INSTRUCTION

## SYSTEM COMPONENTS & INSTALLATION CLEARANCE: QUAD ZONE

### CLEARANCE REQUIRED AROUND UNITS-QUAD ZONE

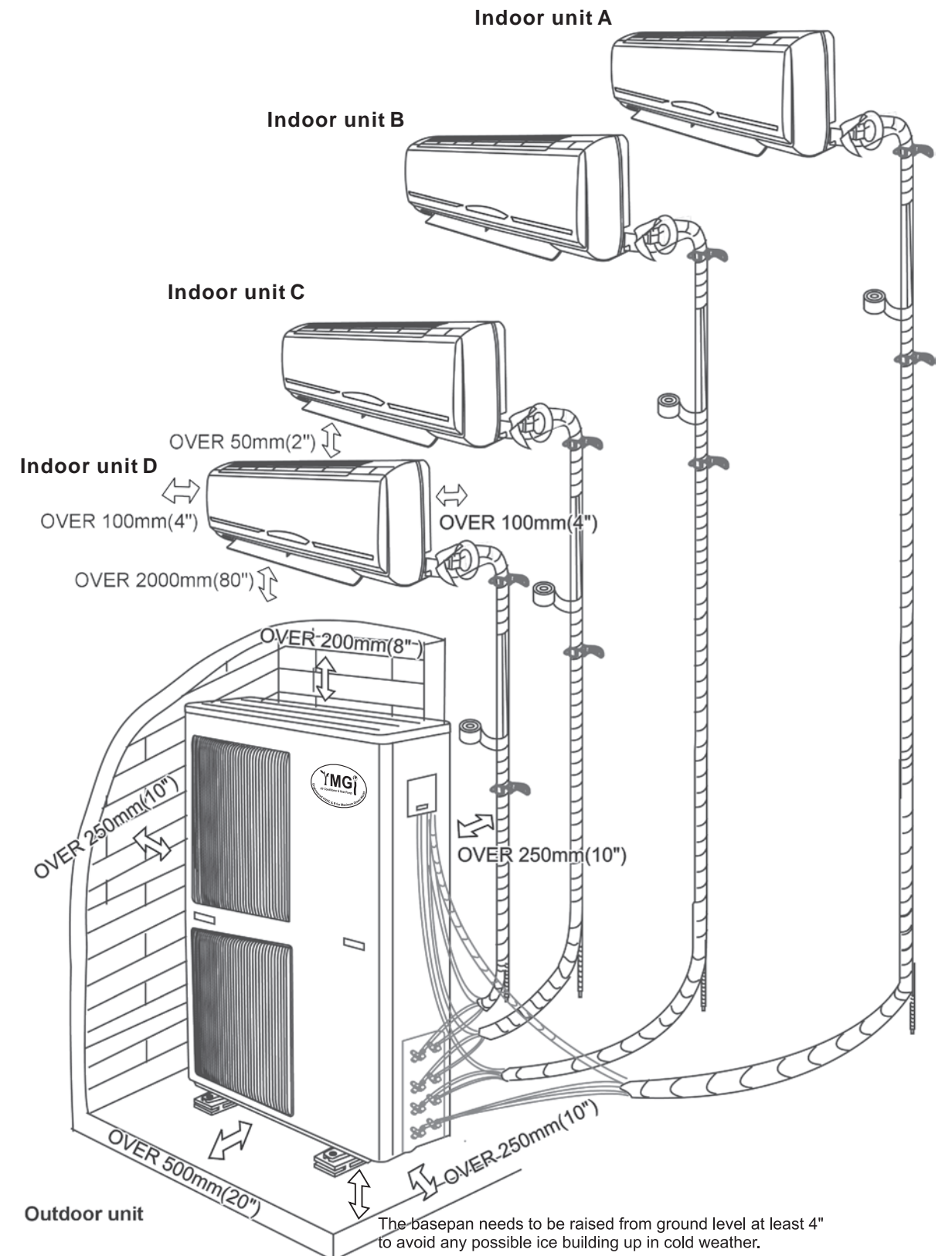

INSTALLER'S INSTRUCTION

## INDOOR UNIT-MAJOR COMPONENTS

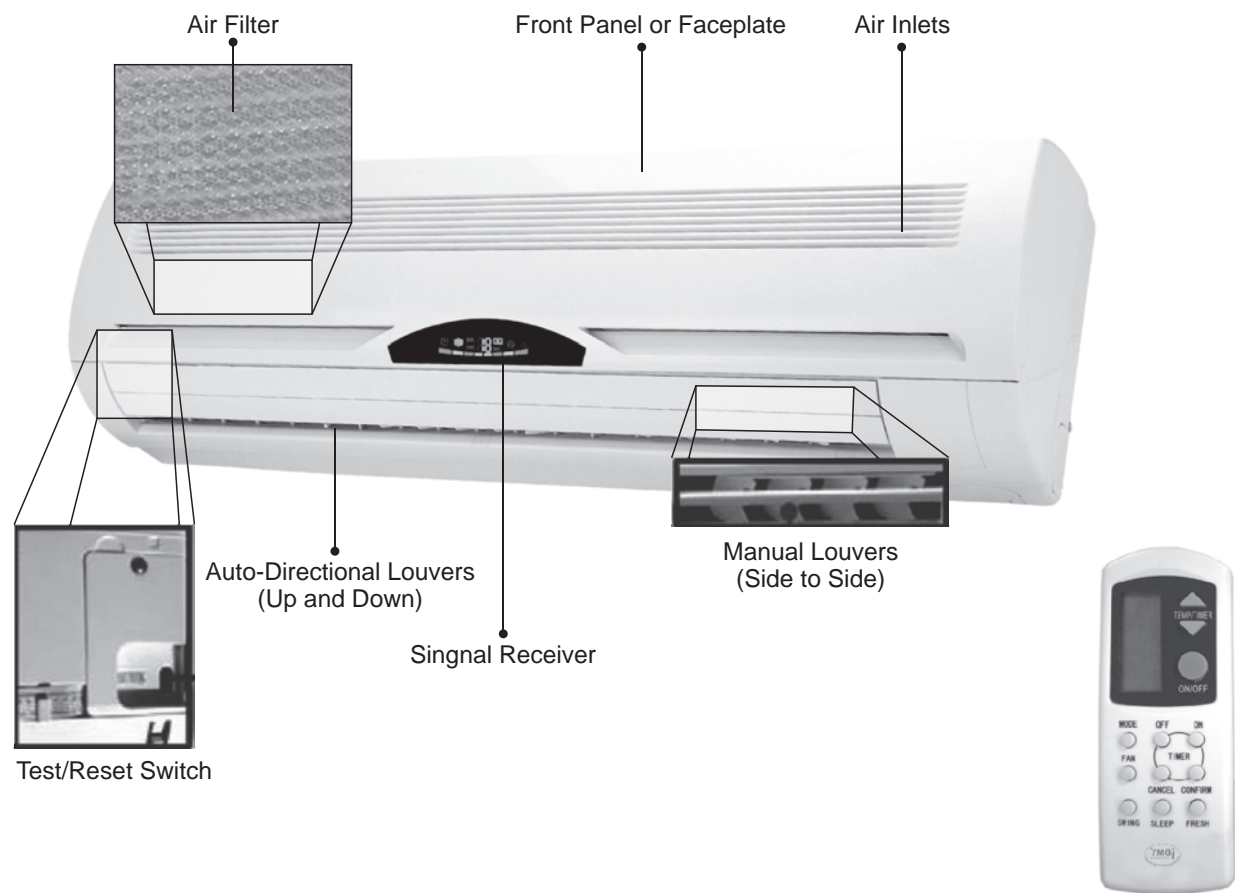

Remote Control (or Optional Wall Thermostat)

## REMOTE OR LINE CONTROL

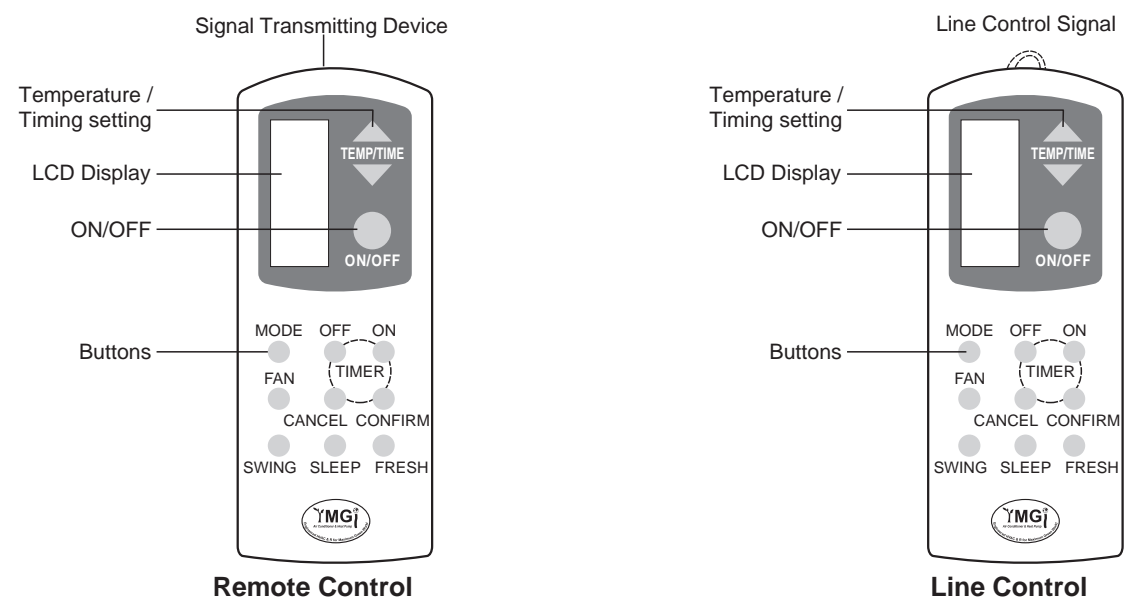

**Notes:**  
 Default control is remote  
 There is no heat mode in cool only air-conditioner

## LED DISPLAY PANEL

(Notes: may be hidden in unit and not exposed to customers)

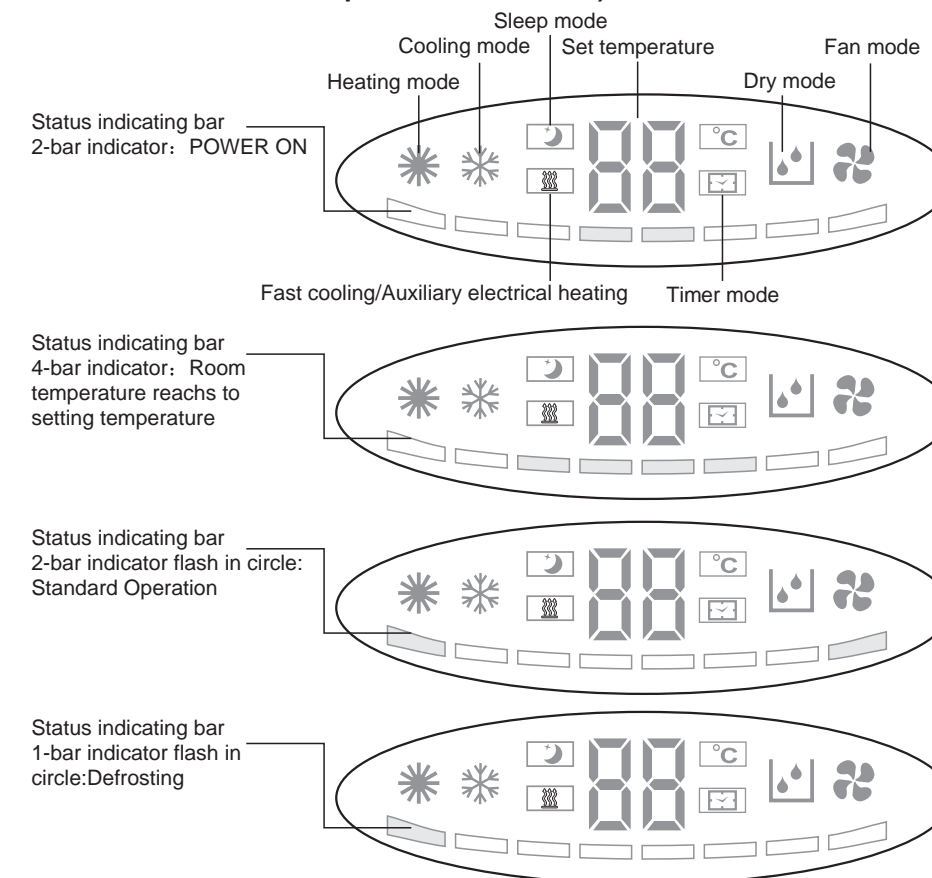

## REPARATION OF REMOTE OR LINE CONTROLER

Open the lid at back, place the 2 AAA 1.5V-LR03 batteries in right polarities.

Short-circuit RESET button as indicated (after the change of the batteries).



### NOTICE

Remove the batteries if you don't use the remote/line control for a long period.

If the remote control does not operate correctly, press RESET button to resolve it.  
 The signal can be transmitted as far as 275 inches (23 feet) away from the indoor unit if the control is pointed towards the front of the indoor unit.  
 Take care of the remote/line control. To avoid any problem, do not drop it on the floor or throw it or expose it to the humidity.  
 When press a button, the indoor unit beeps once or twice, indicating the indoor unit has received control signal.



## FUNCTIONS-REMOTE OR LINE CONTROL

### A. Power

#### BATTERY ON/OFF

- Once two AAA batteries are loaded into the remote control battery compartment in the right polarity, LCD screen shows all signs available for 3 seconds before they all go off the screen totally.
- Once one or two batteries are unloaded from the remote control battery compartment, if no button is touched, the LCD screen display will go off in 15 seconds, if any button is pressed within 15 seconds, the LCD screen display will go off right away.

### B. Run/Stop "ON/OFF" ON/OFF

- If ON/OFF button is pressed the first time, LCD displays AUTO, temperature meter sign, AUTO FAN and SWING from the top to bottom of the LCD screen;
- If ON/OFF button is pressed after power off, LCD displays what is left prior to POWER OFF (including MODE, TEMPERATURE, FAN SPEED, LOUVER, but excluding SLEEP, TIMER and FRESH).

### C. "MODE" MODE

- MODE includes: AUTO, COOL, DRY, FAN and HEAT. Mode changes from one to the next one in a sequence once MODE button is pressed.
  - In AUTO mode, temperature number goes off, all other buttons work.
  - In all other modes, temperature number shows up, all other buttons work.
- Cool only type has not HEAT mode. Each time MODE button is pressed, the operation mode is changed in a sequence: Cool, Dry, Fan only and Heat.

### D. Temperature/Time Adjustment "▲▼" TEMP/TIME

- Normally, these buttons are for temperature up and down adjustment at 1F/press, to decrease 1F, press "▼" button once; to increase 1F, press "▲" button once; If held down for continuous adjustment, number changes at 1F/0.5Sec.
- These buttons are for time adjustment too. If pressed intermittently within 5 seconds after pressing TIMER ON or TIMER OFF, time (hour) changes at 1hour/press; if held down continuously, time changes at 1hour/0.5Sec. Time cycle is between 1-12hrs.
- Temperature/Time change will show up on the Control's LCD display.
- Temperature range is 64 to 86F, Time range is 0 to 24Hr or 0 to 12Hr.

### E. Fan Speed Adjustment FAN

FAN MODE includes: AUTO, LOW, MED and HIGH. Every time "FAN" button is pressed once, fan sign changes once from one to the next one in a sequence: LOW (1-section/fan blade spins slowly), MED. (3-section/fan blade spins a little quicker), HIGH (5-section/fan blade spins quicker), AUTO (4-blade fan).



### F. "FRESH" FRESH

Otherwise claimed, this button is not actuated for:

- \* Fresh air, or
- \* Manual turn on or off supplemental heating

### G. "SLEEP" SLEEP

Press "SLEEP" button to turn the unit into or out of SLEEP mode. When SLEEP button is pressed, star/moon sign either shows up or goes off. If star/moon sign is ON, MODE turns into SLEEP mode (see related function change separately); if pressed again, star/moon sign goes off, MODE turns into the regular.

## FUNCTIONS-REMOTE OR LINE CONTROL

### SLEEP FUNCTION

This function will increase or decrease the set temperature over time.

The COOL mode SLEEP profile is as follows:

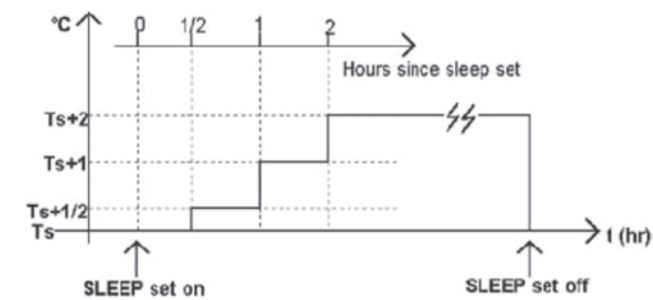

The HEAT mode SLEEP profile is as follows:

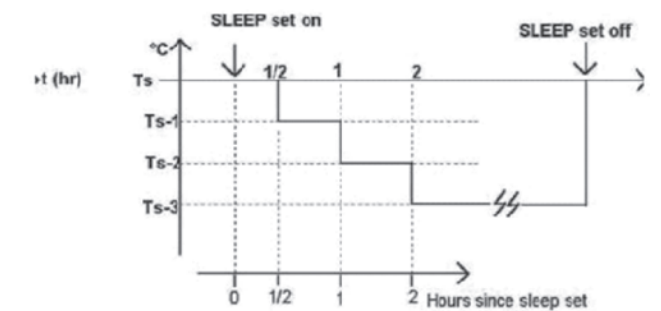

#### When Sleep Mode Gets Started During Cooling

The set temperature will automatically rise 0.5 or 1 degree, once every 1/2 or 1 hour, for several times, in a period of 2 hours, and then stay at  $T_s+2$  until Sleep Mode button is pressed off, following a sample pattern as illustrated at the left side picture above.

This way, fan blows at low speed, set temperature is getting higher so that the room temperature will not be conditioned too low, to accommodate the decreased cooling load when people fall in sleep at night time, and other heat gain also drops due to less activities and energy consumption and dropped outdoor temperature.

#### When Sleep Mode Gets Started During Heating

The set temperature will automatically start to drop 1 degree, once every 1/2 or 1 hour, for several times, in a period of 2 hours, and then stay at  $T_s-3$  until Sleep Mode button is pressed off, following a sample pattern as illustrated at the right side picture above.

This way, fan blows at low speed, set temperature is getting lower so that the room temperature will not be conditioned too warm, to accommodate the decreased heating load when people fall in sleep at night time, and other heat loss also drops.

### H. "SWING" SWING

When power turned on, louver will fully open, then shut off; when power turned off, all shutt off.

Whenever "SWING" button is pressed once, up-down louver(s) will oscillate between up and down, or stop oscillating and stay still, or be turned off.

**WARNING** Control with the remote control to adjust up/down air flow direction, NOT to adjust louvers during swinging.

- In Cool or Dry mode, louver swings to blow air downward in (1), (2) and (3) zones.
- In Heat mode, louver swings to blow air downward in (3), (4) and (5) zones.

In SWING mode, the deflector will not oscillate left-right back and forth, if otherwise stated. Air flow right / left direction change shall be done by manual adjustment. Conduct this adjustment when unit and all moving parts stop running. If adjust during operation, the auto swinging louver may pinch your fingers.

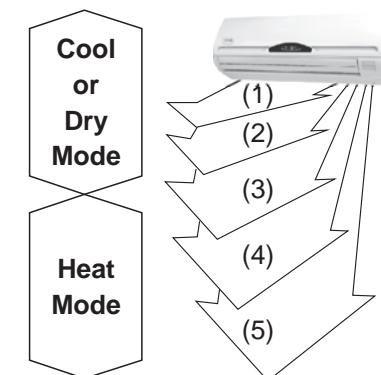

## OPERATION OF THE UNIT

### A. AUTO MODE

When started, operation mode will turn into COOL or DRY or HEAT mode upon room temperature as shown in the following table. Once AUTO operation mode is set, unit will change operation mode as the room temperature changes. If unit restarts after last operation stops for two hours, it will start in the same mode as set before operation was stopped. Press SWING button to change air flow direction up/down.

Room temperatures(RT)	Cool Only Unit		Heat Pump Unit	
	Mode	Pre-Set Temperature	Mode	Pre-Set Temperature
Above 78°F	Cool	77°F	Cool	77°F
From 68-78°F	Dry	(RT-35)°F each 3 minutes	Dry	(RT-35)°F each 3 minutes
Below 68°F	Heat	NA	Heat	73°F

### B. COOL MODE

Pointing remote/line control to the unit, press MODE button until COOL is shown. Press TEMPERATURE ADJUSTMENT button to change the setting temperature. In this mode, you can press SWING button or MANUAL SWING button, if available, to change up/down air flow direction. Press FAN SPEED button to change the fan speed of indoor unit. Once the temperature settled is reached, both indoor and outdoor unit will stop to run. Outdoor unit will work again as soon as the indoor air temperature sensor feels the room temperature is 1 or 2°F higher than set temperature.

Once set temperature is reached, outdoor unit compressor and fan motor will stop working right away, outdoor reversing valve stays un-energized.

- 1) If "circulation" function is built in (2008.06 or earlier production), then the indoor fan will keep on rotating to circulate the air in the room, so that air temperature stratification will not be caused, and then compressor will not come on and go off often.
- 2) If "circulation" function is NOT built in (2008.06 or later production), then the indoor fan will keep on rotating for 60 to 90 seconds to blow out the residual cooling capacity left on cold coil, then shut off.

Once the sensed indoor temperature is 1 or 2 F above set temperature and the 3-minute compressor restarting protection time is passed, indoor unit fan motor and outdoor unit compressor and fan motor will resume to work right away.

### C. DRY MODE

Pointing remote/line control to the unit, press MODE button until DRY is shown. In this mode, you can press SWING button or MANUAL SWING button, if available, to change up/down air flow direction. Press FAN SPEED button to change the fan speed of indoor unit.

### D. FAN MODE

Pointing remote/line control to the unit, press FAN button until DRY is shown. In this mode, you can press SWING button to change up/down air flow direction. Press FAN SPEED button to change the fan speed of indoor unit.

## OPERATION OF THE UNIT

### E. HEAT MODE

Pointing remote/line control to the unit, press MODE button until HEAT is shown.

In this mode, you can press FAN SPEED button to change the fan speed of indoor unit. Press TEMPERATURE ADJUSTMENT button to change the setting temperature. As heat pump starts indoor unit will not start to blow air only until the sensed indoor coil copper tube temperature is warm enough (anti-cold blowing). Outdoor fan motor and compressor will start to work right away. In heat pump mode, larger pipe at outdoor unit should be hot and smaller pipe should be warm.

Once set temperature is reached, outdoor unit compressor and fan motor will stop working right away, outdoor reversing valve stays energized for 2 minutes, while indoor unit will keep on blowing residual heat for a little while before it fully stops.

Once the sensed indoor temperature is 1 or 2 F below set temperature and the 3-minute compressor restarting protection time is passed, outdoor reversing valve will be energized first, then outdoor unit compressor and fan motor will resume to work. Indoor blower will start to blow warm air once the indoor coil is warm enough (sensed temperature).

#### NOTES:

- 1) If "circulation" function is built in (2008.06 or earlier production), then the indoor fan will keep on rotating to circulate the air in the room, so that air temperature stratification will not be caused, and then compressor will not come on and go off often.
- 2) If "circulation" function is NOT built in (2008.06 or later production), then the indoor fan will keep on rotating for 60 to 90 seconds to blow out the residual heating capacity left on warm/hot coil, then shut off.
- 3) During heat pump mode, outdoor unit may need to defrost to get rid of ice/frost built up in cold weather as much as possible. In this case indoor fan motor stops, outdoor compressor works, outdoor fan motor cycles unit defrost cycle quits upon both sensed temp and/or time.
- 4) Heater will start as supplemental heat to heat pump, once the outdoor temperature is low and the difference between sensed indoor temperature and sensed indoor coil temperature is lower than the designated value.
- 5) Suggest set indoor temperature between 68°F and 75°F. Heating efficiency becomes inferior when room temperature is below 35°F.



### F. TIMER

#### "TIMER ON" AND "TIMER OFF"

"TIMER ON" is to set up the hour span from now on when the unit will be turned ON. "TIMER OFF" is to set up the hour span from now on when the unit will be turned OFF. "TIMER ON" or "TIMER OFF" set-up must be input by pressing the "TIMER CONFIRM" button.

Once pressed, TIMER related signs show up and hour sign blinks. If pressing TIMER "ON" or "OFF" button, time changes at 1hr/press (being held down intermittently) or 1hr/0.5second (being held down continuously); If no action 5 seconds after pressing TIMER "ON" or "OFF", or "CONFIRM" button is not pressed 5 seconds after time adjustment is made, TIMER related signs will go off in another 10 seconds.

#### "CANCEL"

Once TIMER "CANCEL" button is pressed, previous TIMER set-up shall be cleared and all TIMER related signs go off.

**NOTICE:** To cancel timer, press CANCEL button of the Timer. If power sets off, time must be reset, otherwise Timer Operation will not be right.

#### "CONFIRM"

Once TIMER "CONFIRM" button is pressed, set-up of TIMER "ON" or TIMER "OFF" is actuated.

## SERVICE AND MAINTENANCE

### Unit Not Used for a Long Time

Start FAN 1 hour to completely dry the inside of the indoor unit.  
Set to the HEAT mode, then select the highest temperature as the control can go, then indoor fan will be on. Run for 1 hour.



Turn off the unit by remote or line control, then turn off circuit breaker.

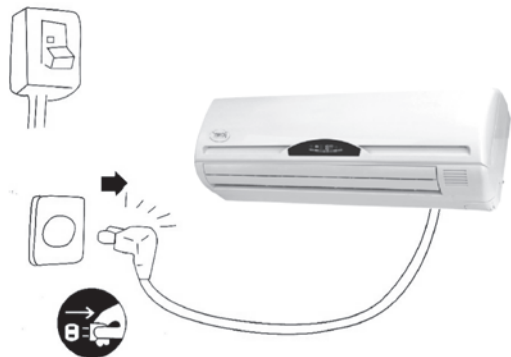

Take the batteries out of the remote or line control.

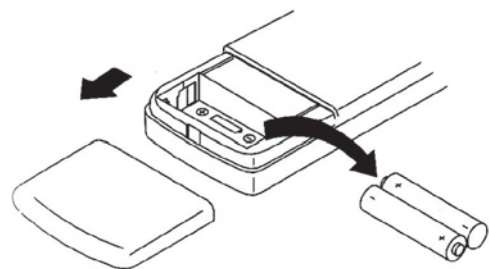

### Prior to Using the Unit

Clean filters and replace them back to their original positions. Clean indoor unit with soft cloth. Do not use gasoline, benzene, grinding powder, detergent, insecticide, etc. to clean units as they can hurt the units.



Check to make sure that inlets and outlets of indoor and outdoor units not be covered or blocked. Clean filter, if necessary.

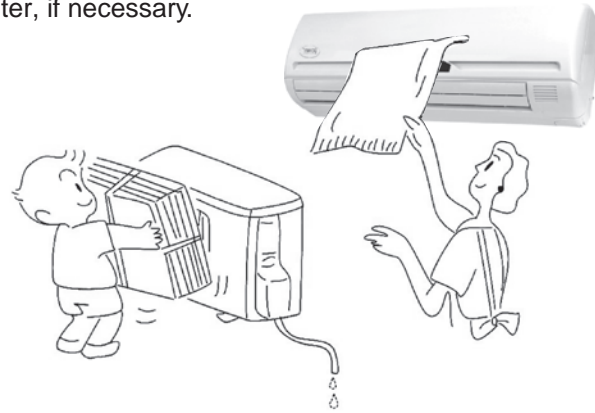

Check to make sure ground wire not loose. Put batteries into control and turn on unit. Run FAN only for 1 hour before moving onto other mode.

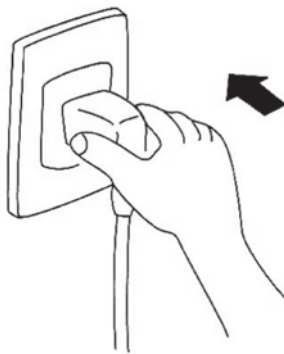

## SERVICE AND MAINTENANCE

- Regular Air Filter, Deodorization Filter or Air Cleaner must be cleaned once a while, depending upon air quality and unit application.
- Open Front Panel only After Unit Stops Running Completely.

### Check and Clean Air Filter

1. Take out filters.

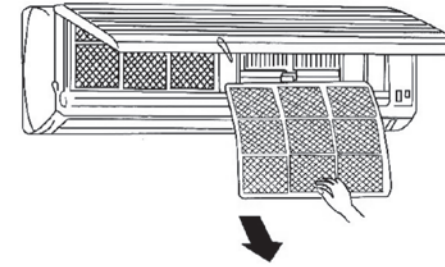

2. Clean filters with a vacuum cleaner or by patting them gently (if they are very dirty, wash them in warm water below 104°F dissolved with neutral solution of washing detergent).

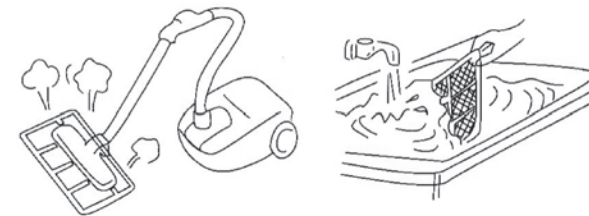

3. Rinse filters with clean water, then dry them in cool air.

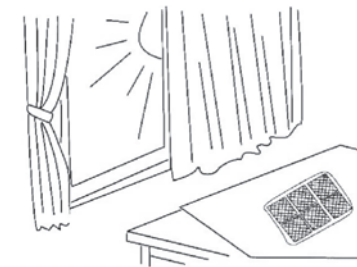

4. Insert them back to their original positions securely. Close plastic front panel.

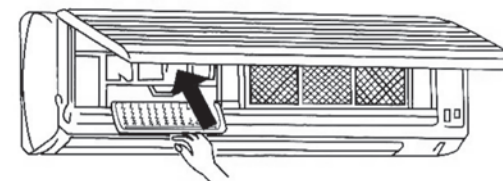

### Check and Clean Deodorization Filters and Air Cleaner

1. Take out filters, deodorization filter or air cleaner, if available.

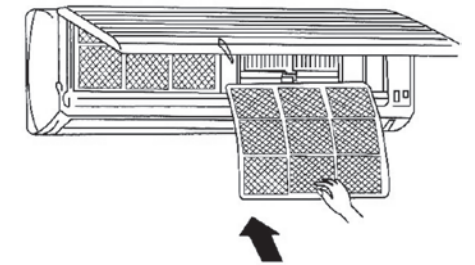

2. Clean deodorization filter, air cleaner with warm water below 100°F dissolved with neutral washing detergent.



3. Rinse filters with clean water, then dry them in cool air.

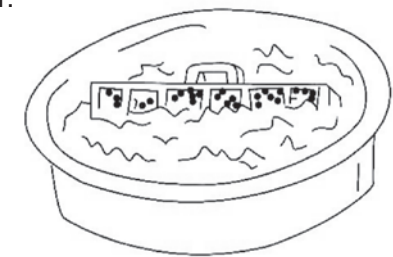





4. Insert them back to their original positions, Close plastic front panel.







## DOUBTING ABOUT UNIT FAILURE

If your problems could not be resolved with procedure described below, please stop your unit and contact the installer or distributor.

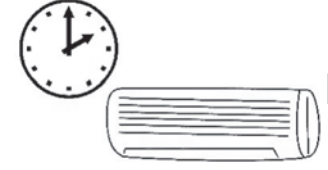
Phenomenon	Analysis and Solution
<p>Unit does not operate at all.</p> 	<ul style="list-style-type: none"> <li>• Power blackout?</li> <li>• Circuit breaker trips?</li> <li>• Fuse in panel blown?</li> <li>• Is voltage higher or than 10% of the required rated value?</li> <li>• Wire loose or damaged?</li> <li>• Check power piror to checking the unit.</li> </ul>
<p>Remote control does not display.</p> 	<ul style="list-style-type: none"> <li>• If disturbed abnormally or operation modes changed too frequently, sometimes remote control would lose functions. Remove batteries and reposition batteries.</li> <li>• If remote control displays unclear or displays all symbols, need to replace with good batteries.</li> </ul>
<p>Unit doesn't run after ON/OFF button is pressed.</p> 	<ul style="list-style-type: none"> <li>• There are many ways to protect the unit. Unit stops as per microprocessor program safety instructions. Please wait a little while.</li> <li>• Pressed ON/OFF too many times? Press it firmly to check if the indoor unit beeps.</li> </ul>
<p>Cooling and heating is not satisfied after running for a long time.</p> 	<ul style="list-style-type: none"> <li>• Does temperature set up right?</li> <li>• Dirty filter?</li> <li>• Unit inlet or outlet blocked?</li> <li>• Unit still in sleep mode?</li> <li>• Indoor fan speed set at low?</li> <li>• Doors and windows are open?</li> <li>• Too much sunshine or extra heat in room?</li> </ul>
<p>Blower doesn't run while outdoor unit is running during HEAT mode.</p> 	<ul style="list-style-type: none"> <li>• Air will not be immediatly blown out at the start of the HEAT mode. Blower won't work until the indoor coil is warm enough.</li> <li>• Coil copper tube temperature sensor should be in the copper tube holder securely with wires connected well.</li> </ul>

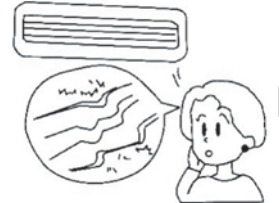
## DOUBTING ABOUT UNIT FAILURE

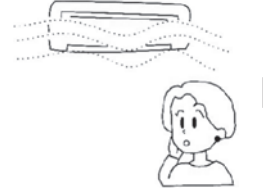
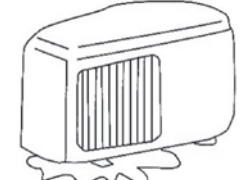
Phenomenon	Analysis and Solution
<p>Indoor unit fan stops for about 10 minutes while outdoor unit is still in operation at heating mode.</p> 	<ul style="list-style-type: none"> <li>• It may be defrosting the outdoor unit coil. This process should complete in about 10 minutes at most (it freezes when outdoor temperature is low and humidity is high).</li> </ul>
<p>You may hear the craking sounds.</p> 	<ul style="list-style-type: none"> <li>• Friction sounds could be caused by expansion and contraction of front panel due to temperature changes at unit startup or shutdown.</li> </ul>
<p>You may hear the sound like running water.</p> 	<ul style="list-style-type: none"> <li>• Sound of running refrigerant in air-conditioner due to its expansion or flowing.</li> <li>• Sound of accumulated condensate dripping from the heat-exchanger to dain pan.</li> <li>• Melting sounds of frost on heat-exchanger.</li> </ul>
<p>You may hear "POOSH" sound and "CLICK" sound.</p> 	<ul style="list-style-type: none"> <li>• "POOSH" sound of refrigerant flow change when cooling or heating mode is finished.</li> <li>• "Click" sound of fan or compressor when contactors being engaged.</li> </ul>
<p>You may smell some odor blowing out of the air that air-conditioner.</p> 	<ul style="list-style-type: none"> <li>• Odors from the filter or coil (dust, moisture, fungi, mold...). Need to clean filter.</li> <li>• Heater is clicked on. Don't need to be worried about.</li> <li>• If abnormal, need to check the unit.</li> </ul>
<p>Condensate found in outdoor unit drain pan.</p> 	<ul style="list-style-type: none"> <li>• During cooling, condensate from pipes or coils accumulated.</li> <li>• During heating, condensate at heat-exchanger coil drips.</li> <li>• During heating, at defrosting, melt ice builds up condensate.</li> </ul>



## DIAGNOSIS CODE & TROUBLE-SHOOTING GUIDELINE

### DIAGNOSIS CODE, POSSIBLE CLAUSES, AND SUGGESTED ACTIONS TO USER AND TECHNICIAN:

Codes	Descriptions	Possible Reasons	Suggestion to User	Technician Trouble-Shooting
E1	Condensate Full in drain pan	Dain pan dirty, drain hose clogging, water level switch failure, loose connection, bad control board/ components, etc.	Check if drain hose is clogged; if not, need to call your installing or service technician.	<ol style="list-style-type: none"> <li>1) Shut off power;</li> <li>2) Follow possible clauses listed at the left, to check one by one;</li> <li>3) To save time for quick diagnosis as much as possible, suggest your technician to make appointment with YMGI tech. support, and call us while the technician is at job site.</li> <li>4) Better to check the unit, get problems and model model #, and serial # ready, before calling YMGI tech. support.</li> <li>5) Need the technician physically, at the job site, use right tools and experience, to find all the clauses and correct or fix the problems and not to leave any bugs.</li> </ol>
E2	Indoor air temp. sensor failure	Bad temperature sensor; loose connection, damaged wires, bad control board/ components, etc.	Lift up grille/cover, to check if the sensor looks bad or drops out of holding socket/ pocket; or, to call installing or service technician.	
E3	Indoor coil copper tube sensor failure	Bad temperature sensor; loose connection, damaged wires, bad control board/ components, etc.		
E4	Abnormal cooling	Dirty filters/coils, refrigerant leaks over time, pipe too long, kinks or clogging in pipe line or valves, pipe damage, sensor failure, compressor or board or other component failures, etc.	<ol style="list-style-type: none"> <li>1) Regularly check and clean indoor unit filters, indoor and outdoor coils.</li> <li>2) The service valves at outdoor unit should be generally cool at cooling mode; hot at heating mode;</li> <li>3) Call your installing or service technician to check unit.</li> </ol>	
E5	Abnormal heating			
E6	Cooling-outdoor coil low temp. protection	Outdoor too cold to run cooling mode, windy, too much refrigerant, short piping, etc.		<ol style="list-style-type: none"> <li>1) Check if these are caused by installation or component failure;</li> <li>2) There could be nothing abnormal, but the unit is at protection mode, which means the current ambient temperature is not proper to run the unit;</li> <li>3) If there is something wrong, need to find all the clauses and correct or fix the problems and not to leave any bugs.</li> </ol>
E7	Cooling-Indoor coil anti-freeze protection	Dirty filter/coils, indoor fan motor failure, loose blower wheel/motor connection, too much or less refrigerant, pipe/cap. tube/valve clogging, etc.	<ol style="list-style-type: none"> <li>1) Shut off the unit;</li> <li>2) Cooling, wait until weather allows the unit to re-start, or switch to alternative cooling equipment which allows lower ambient cooling;</li> </ol>	
E8	Heating-outdoor coil high temp. protection	Outdoor temperature too warm to run heating mode, too much refrigerant, short piping, etc.	<ol style="list-style-type: none"> <li>3) Heating, wait until weather allows the unit to re-start, or switch to base-board heater, gas furnace or other alternative heating sources during cold hours/days.</li> </ol>	
E9	Heating-indoor coil anti-to hot protection	Dirty filter/coils, indoor fan motor failure, loose blower wheel/motor connection, too much refrigerant, pipe/cap. tube/valve clogging, etc.		
E0	Heating-outdoor coil too cold protection	Outdoor temperature is too cold to run heat pump/ heating.		

## WARRANTY AND TECH. SUPPORT

YMGI warrants to the purchaser/owner(s) that YMGI products be free from defects in material and workmanship under the normal use and maintenance, with the standard Limited Product Warranty Policies that comes with the unit or sales package.

### YMGI IS NOT RESPONSIBLE FOR

- \* Damage or repairs required as a consequence Customer do-it-yourself(DIY) installation and/or any other faulty installation or improper application.
- \* Damage or repairs needed as a consequence of any misapplication, abuse, improper servicing, unauthorized alteration, or improper operation.
- \* Damage as a result of floods, winds, fires, lightning, accidents, corrosive atmosphere, or other conditions beyond the control of YMGI.
- \* Any damages to person or property of whatever kind, direct or indirect, special or consequential, whether resulting from use or loss of use of the product.
- \* Failure to start due to voltage conditions, blown fuses, open circuit breakers, or other damages due to the inadequacy or interruption of electrical service.
- \* Parts not supplied or designated by YMGI.
- \* Products installed outside USA or Canada.
- \* Regular equipment maintenance or field service or field inspection.
- \* Any problems due to improper cooling and heating load calculation of the room/building the air conditioner/heat pump system is to be installed. Equipment users can get the calculation schedule from your room/building architect or your installation or related service HVAC contractor, who should have knowledge and tools to do these calculation correctly.
- \* Any problems due to improper sizing and selecting air conditioner/heat pump system. These equipment sizing and selection work should be conducted by either your room/building architect or your installation or related service HVAC contractor, who should have knowledge and tools to do these calculation correctly, and get your approval, before your purchasing these air conditioner or heat pump equipment.
- \* Any problems due to improper installing of the air conditioner/heat pump system. Installation should be conducted by currently licensed HVAC technician, following manufacturer installation instructions, all governing safety codes, with care and professionalism.
- \* Any problems due to improper operation of the air conditioner/heat pump system. Users shall keep the manual and look up in the manuals for the correct understanding how the unit will work and how to operate the unit correctly.
- \* Any problems due to improper maintenance of the air conditioner/heat pump system. Like a car, regular maintenance or yearly checking is necessary for the unit to work properly for you, before the season comes. For example, air filter shall be checked for cleanliness from time to time. Remote control batteries shall be checked for enough power, before judging the unit is not working...

### CONTACT FOR FIELD SERVICE OR REPAIR

The following people, in a prioritized sequence, will take care of your request or issue:

- 1) The original installer; otherwise,
- 2) Your current service contractor; otherwise,
- 3) Authorized contractor in YMGI list that is close to you; otherwise,
- 4) Authorized Distributor in YMGI Distributor list; otherwise,
- 5) Contractor/Distributor you prefer who is close to you.

### CONTACT FOR GENERAL TECHNICAL QUESTIONS OR SUPPORT, IN A SEQUENCE:

- 1) The original installer; otherwise,
- 2) The current service contractor; otherwise,  
The original licensed installer or current service contractor should be contacted first of all, since they installed the unit and/or know more details than anybody else.  
They will check the unit and find out the problems with the professional knowledge about HVAC and electric product installation by using special tools or instrument.  
They can contact YMGI technical support for technical help during unit installation or inspection.  
Product model and serial numbers needed, which can be found on unit nameplate sticker, so that our technician can quickly identify the unit, parts and wiring diagrams, among our many products and models.
- 3) The distributor; where the unit is purchased from otherwise,
- 4) YMGI Technical Support:  
Tel: (866) 833-3138\*703      Email: techsp@ymgigroup.com



**USER NOTES AND SERVICE LOG**

**USER NOTES**

Put down whatever questions you have or problems you have seen as a unit history:

No.	Date	Questions or Problems	Remarks

**SERVICE/MAINTENANCE LOG**

Put down whatever questions you have or problems you have seen as a unit history:

No.	Date	Service/Maintenance Conducted	Person/Phone

**MEMO**

---

---

---

---

---

---

---

---

---

---

---

---

---

---

---

---

---

---

---

---

---

---

---

---

WARRANTY & SUPPORT

WARRANTY & SUPPORT

